



OPERATING INSTRUCTIONS
MANUEL D'UTILISATION
BEDIENUNGSANLEITUNG
ISTRUZIONI PER L'USO
MANUAL DE INSTRUCCIONES





AX-5505

Stereo Integrated Amplifier
Amplificateur intégré stéréophonique
Stereo-Vollverstärker
Amplificatore Integrato Stereo
Amplificador Integrado Estéreo

CE

Introduction

READ THIS BEFORE OPERATING YOUR UNIT

	CAUTION RISK OF ELECTRIC SHOCK DO NOT OPEN			This symbol is intended to alert the user to the presence of uninsulated "dangerous voltage" within the product's enclosure that may be of sufficient magnitude to constitute a risk of electric shock to persons.
CAUTION : TO REDUCE THE RISK OF ELECTRIC SHOCK, DO NOT REMOVE COVER (OR BACK). NO USER-SERVICEABLE PARTS INSIDE. REFER SERVICING TO QUALIFIED SERVICE PERSONNEL.				This symbol is intended to alert the user to the presence of important operating and maintenance (servicing) instructions in the literature accompanying the appliance.

WARNING : TO REDUCE THE RISK OF FIRE OR ELECTRIC SHOCK, DO NOT EXPOSE THIS APPLIANCE TO RAIN OR MOISTURE.

Caution regarding installation
 Note : For heat dispersal, do not install this unit in a confined space such as a bookcase or similar enclosure.

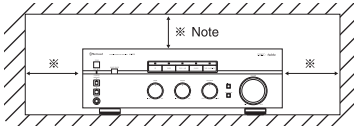
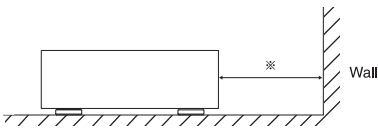



Do not block ventilation openings or stack other equipment on the top.

FOR YOUR SAFETY		
EUROPE AUSTRALIA	220 V - 240 V	Units shipped to Australia are designed for operation on 240 V AC only. To ensure safe operation, the three-pin plug supplied must be inserted only into a standard three-pin power point which is effectively earthed through the normal household wiring. Extension cords used with the equipment must be three-core and be correctly wired to provide connection to earth. Improper extension cords are a major cause of fatalities. The fact that the equipment operates satisfactorily does not imply that the power point is earthed and that the installation is completely safe. For your safety, if in any doubt about the effective earthing of the power point, consult a qualified electrician. PAN-EUROPEAN UNIFIED VOLTAGE All units are suitable for use on supplies 220-240 V AC.

CAUTION
<ul style="list-style-type: none"> • Leave a space around the unit for sufficient ventilation. • Avoid installation in extremely hot or cold locations, or in an area that is exposed to direct sunlight or heating equipment. • Keep the unit free from moisture, water, and dust. • Do not let foreign objects in the unit. • The ventilation should not be impeded by covering the ventilation openings with items, such as newspapers, table-cloths, curtains, etc. • No naked flame sources, such as lighted candles, should be placed on the unit. • Please be care the environmental aspects of battery disposal. • The unit shall not be exposed to dripping or splashing for use. • No objects filled with liquids, such as vases, shall be placed on the unit. • Do not let insecticides, benzene, and thinner come in contact with the set. • Never disassemble or modify the unit in any way. ■ Notes on the AC power cord and the wall outlet. <ul style="list-style-type: none"> • The unit is not disconnected from the AC power source(mains) as long as it is connected to the wall outlet, even if the unit has been turned off. • To completely disconnect this product from the mains, disconnect the plug from the wall socket outlet. • When setting up this product, make sure that the AC outlet you are using is easily accessible. • Disconnect the plug from the wall outlet when not using the unit for long periods of time.

Information for Users on Collection and Disposal of Old Equipment and used Batteries



These symbols on the products, packaging, and/or accompanying documents mean that used electrical and electronic products and batteries should not be mixed with general household waste. For proper treatment, recovery and recycling of old products and used batteries, please take them to applicable collection points, in accordance with your national legislation.



By disposing of these products and batteries correctly, you will help to save valuable resources and prevent any potential negative effects on human health and the environment which could otherwise arise from inappropriate waste handling.



For more information about collection and recycling of old products and batteries, please contact your local municipality, your waste disposal service or the point of sale where you purchased the items.

Pb

[Information on Disposal in other Countries outside the European Union]
 These symbols are only valid in the European Union. If you wish to discard these items, please contact your local authorities or dealer and ask for the correct method of disposal.

Note for the battery symbol (bottom two symbol examples):
 The sign Pb below the symbol for batteries indicates that this batteries contains lead.

ENGLISH

CONTENTS

ENGLISH

Introduction

- READ THIS BEFORE OPERATING YOUR UNIT | 2

System Connections | 4

Front Panel Controls | 6

DIGI LINK III System Remote Controls | 7

- REMOTE CONTROL OPERATION RANGE | 8
- LOADING BATTERIES | 8

Operations

- LISTENING TO A PROGRAM SOURCE | 9
- RECORDING | 11

Troubleshooting Guide | 12

Specifications | 13

System Connections

- Do not connect the amplifier to the wall AC outlet when plugging and unplugging connection cords.
- Be sure to connect the white RCA pin cords to the L (left) and the red RCA pin cords to the R (right) jacks when making connections.
- Make connections firmly and correctly. If not, it can cause loss of sound, noise or damage to the amplifier.

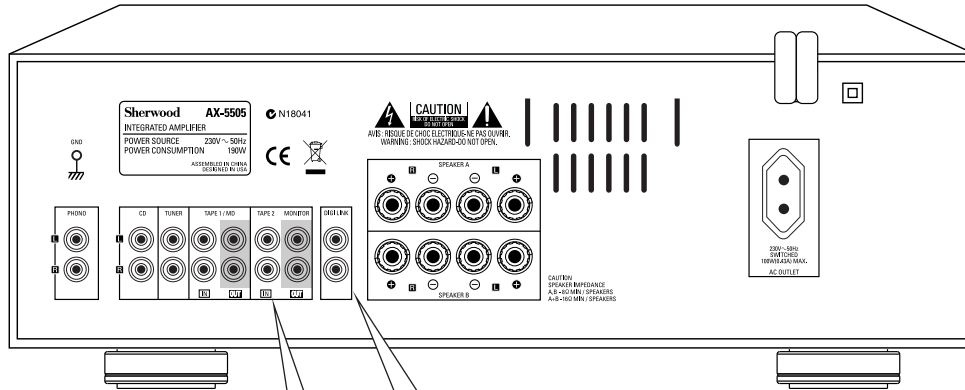

CONNECTING AUDIO COMPONENTS

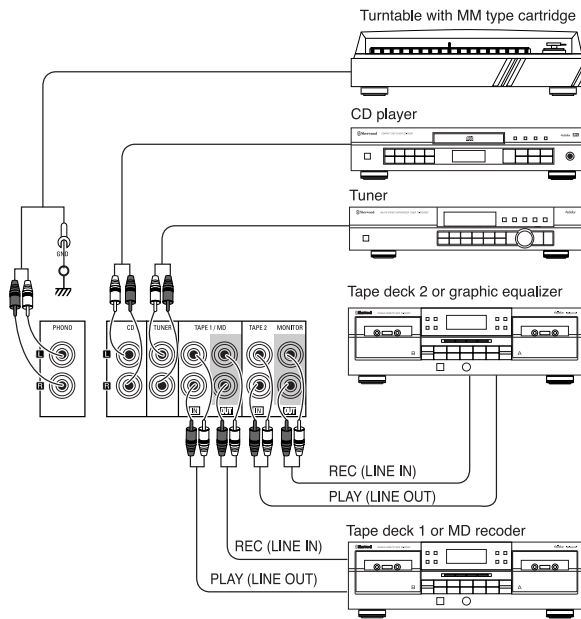

- The TAPE1/MD IN/OUT jacks may also be connected to the LINE OUT/IN jacks of an additional MD recorder.
- The TAPE2 MONITOR IN/OUT jacks may also be connected to the LINE OUT/IN jacks of an optional graphic equalizer.

CONNECTING SYSTEM CONTROL

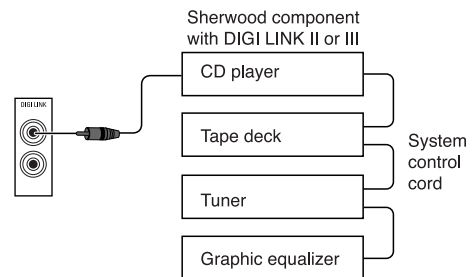

- Connect this jack to the DIGI LINK jack of the external Sherwood component that uses the DIGI LINK II or III remote control system.

ENGLISH

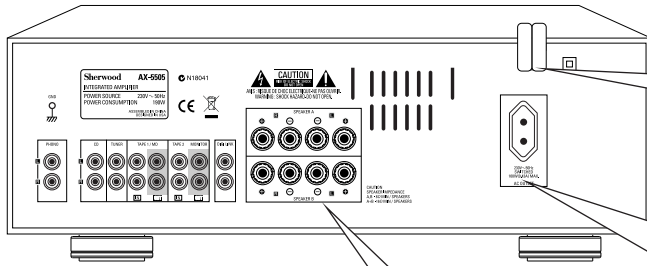

■ AC INPUT CORD

Plug this cord into a wall AC outlet

■ SWITCHED AC OUTLET

- This outlet is switched on (power on mode) and off (standby mode) according to power control as follows; (Maximum total capacity is 100 W (0.43A))

☐ Standby mode - switched AC outlet off
 ☐ Power on mode - switched AC outlet on

■ CONNECTING SPEAKERS

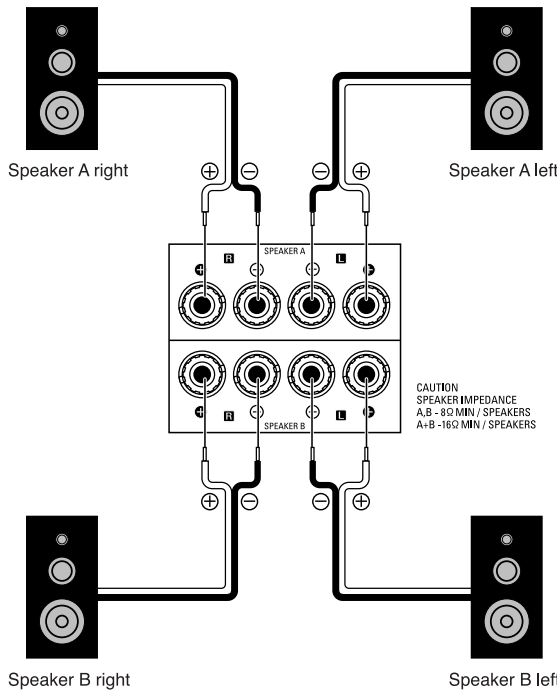

- This amplifier enables you to listen to two pairs of speakers individually or in various combinations. Connect your main speakers to the SPEAKER A terminals and use the SPEAKER B terminals for the remote pair located elsewhere in your home.
- Be sure to connect speakers firmly and correctly according to the channel (left and right) and the polarity (+ and -).
- Do not let the bare speaker wires touch each other or any metal part of this unit. This could damage this unit and/or the speakers.
- Never touch the speaker terminals while the AC input cord is connected to the wall AC outlet. Doing so could result in electric shocks.

Note : For safe amplifier operation, use the speakers with impedance of over 8Ω when you use either SPEAKER A or B terminals and use the speakers with impedance of over 16Ω when you use both SPEAKER A and B terminals.

■ Connecting speaker wire

1. Strip away approx. 10 mm (3/8 inch) of wire insulation, then twist the wire ends tight.



2. Loosen by turning the speaker terminal counter-clockwise.



3. Insert the bare part of the wire.



4. Tighten by turning it clockwise.



Front Panel Controls

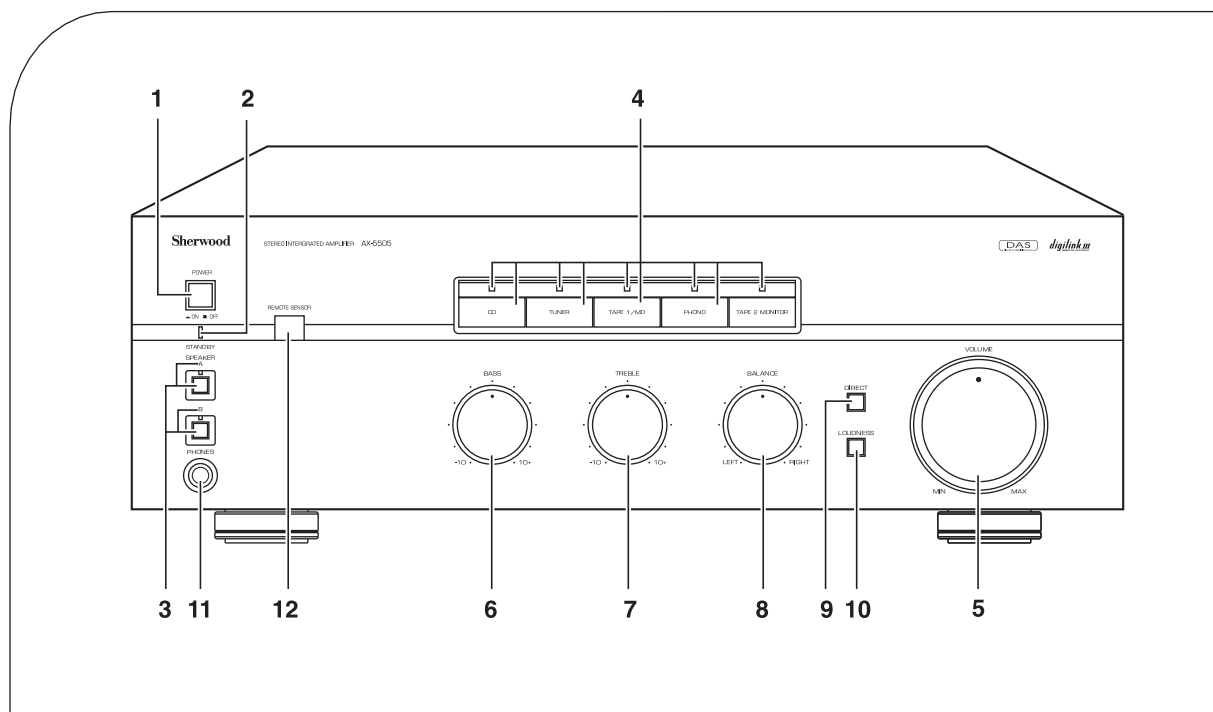

1. POWER SWITCH

Press this switch to enter the power off or the standby mode.

2. STANDBY INDICATOR

In the standby mode, this indicator lights up.

3. SPEAKER SELECTOR A, B BUTTONS/INDICATORS

Press the button to switch the desired speakers on or off.

4. INPUT SELECTOR BUTTONS/INDICATORS

Press the button to select the desired input source.

- When the TAPE 2 MONITOR indicator lights up, other inputs cannot be heard from the speakers.

To listen to an input source other than TAPE 2 MONITOR, be sure to set the TAPE 2 MONITOR button to off.

5. VOLUME CONTROL KNOB

Adjust the volume to a comfortable listening level.

6. BASS CONTROL KNOB

Adjust the low-frequency tone.

- The center position is the flat (normal) condition.

7. TREBLE CONTROL KNOB

Adjust the high-frequency tone.

- The center position is the flat (normal) condition.

8. BALANCE CONTROL KNOB

Adjust the stereo balance between left and right speakers.

- The center position is the normal condition.

9. TONE DIRECT SWITCH

Press this switch to bypass the tone (bass and treble) circuitry for pure sound.

10. LOUDNESS SWITCH

Press this switch to emphasize the sound of frequencies that are difficult to hear at low volume levels.

- The frequency emphasis varies according to the volume level at which you are listening.

11. HEADPHONE JACK

Stereo headphones with a standard 1/4 inch plug can be plugged into this jack for private listening.

- When listening with headphones, turn off both SPEAKER SELECTOR A and B buttons.

12. REMOTE SENSOR

This receives the signals from the system remote control unit.

DIGI LINK III System Remote Controls

- You can remotely control not only this amplifier but also Sherwood compatible components bearing the DIGI LINK II or III logo.
- For system remote control operation, first make the DIGI LINK connections.

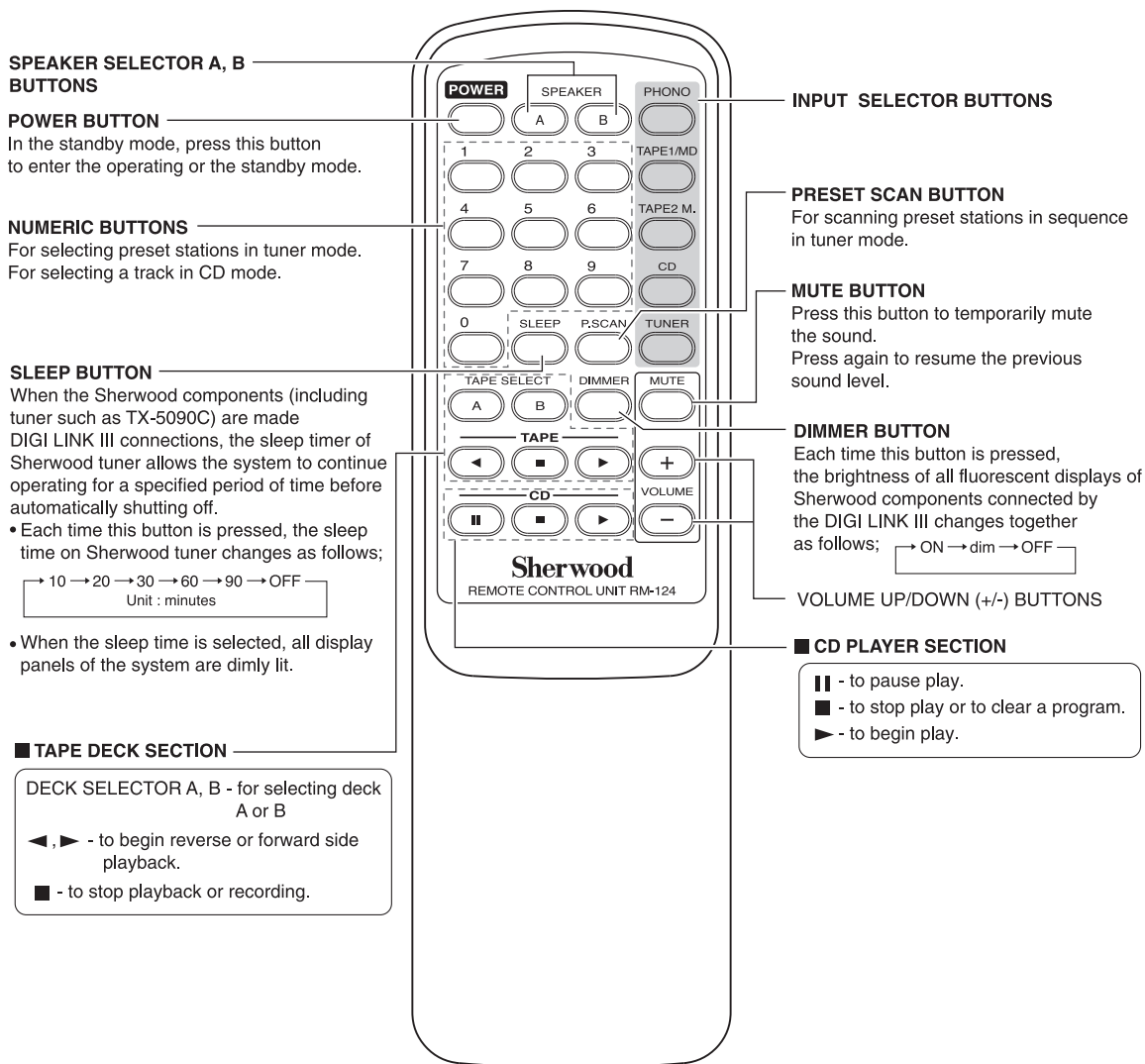

- In the DIGI LINK III remote control system, if pressing PLAY, etc. on CD player or tape deck, CD or TAPE 2 MONITOR is selected automatically without selecting the input source and then PLAY, etc. starts.

Notes :

- Some functions for CD player or tape deck may not be available.
- For details about functions, refer to the operating instructions of each component.

REMOTE CONTROL OPERATION RANGE

The diagram illustrates the remote control's operational range. A Sherwood receiver is shown with a remote sensor on its front panel. A cone representing the remote's range extends 7 meters from the sensor, covering a 30-degree angle on both sides. A remote control unit is shown at the base of this cone, pointing towards the receiver.

- Use the remote control unit within a range of about 7 meters (23 feet) and angles of up to 30 degrees aiming at the remote sensor.

ENGLISH

LOADING BATTERIES

1. Remove the cover.

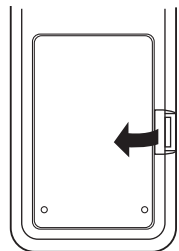

2. Load two batteries matching the polarity.

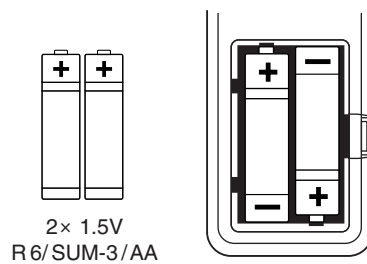

- Remove the batteries when they are not used for a long time.
- Do not use the rechargeable batteries (Ni-Cd type).

Operations

LISTENING TO A PROGRAM SOURCE

Before operation

- Enter the standby mode.

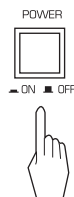

- The STANDBY indicator lights up. This means that the amplifier is not disconnected from the AC mains and a small amount of current is retained to support the memorized contents and operation readiness.
- To switch the power off, push the POWER switch again, then the power is cut off and the STANDBY indicator goes off.

1. In the standby mode, turn the power on.

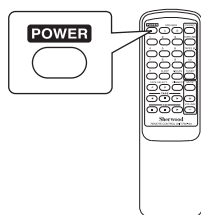

- Each time the POWER button on the remote control is pressed, the amplifier is turned on to enter the operating mode or off to enter the standby mode.
- In the standby mode, if the INPUT SELECTOR button is pressed, the amplifier is turned on automatically and the desired input is selected.

■ SYSTEM POWER ON/OFF

- If the POWER switch of Sherwood component connected by the DIGI LINK II or III is kept pushed and its AC input cord is plugged in the switched AC outlet, each time the amplifier becomes the standby or the operating mode, its power is turned off or on.
- Under the same conditions, if its AC input cord is not plugged only in the switched AC outlet, when the amplifier becomes the standby mode, only its display is off (meaning that a small amount of current is retained for operation readiness, etc.)

2. Switch the desired speakers on.

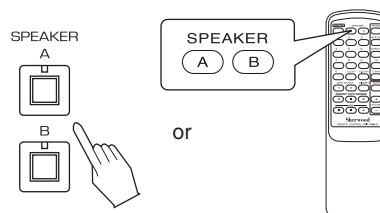

- Then the corresponding SPEAKER indicator lights up and the sound can be heard from the speakers connected to "SPEAKER A" or (and) "SPEAKER B" terminals.
- When using headphones for private listening, press both SPEAKER SELECTOR A and B buttons to switch the speakers off.

■ **Note** : For safe amplifier operation, be sure to check impedance of the speakers connected. (Refer to "CONNECTING SPEAKERS" on page 5)

3. Select the desired input source.

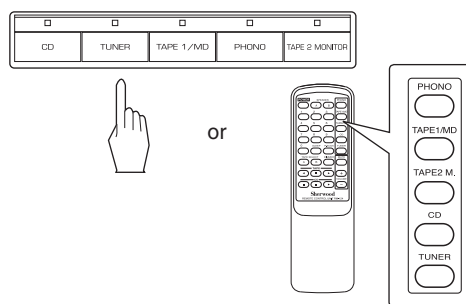

- Then the corresponding indicator lights up.
- When the TAPE 2 MONITOR button is set to on so that the TAPE 2 MONITOR indicator lights up, other inputs can not be heard from the speakers. To listen to an input source other than TAPE 2 MONITOR, be sure to set the TAPE 2 MONITOR button to off.

■ TAPE MONITOR function

You can connect either a tape deck or a graphic equalizer to the amplifier's TAPE 2 MONITOR jacks. Only when you listen to the component connected to these jacks, set the TAPE 2 MONITOR button to on. If you connect a 3-head tape deck, you can listen to the sound being recorded during recording, not the source sound.

For further details, refer to the operating instructions of the component connected.

4. Operate the selected component for playback.

5. Adjust the volume to a comfortable listening level.

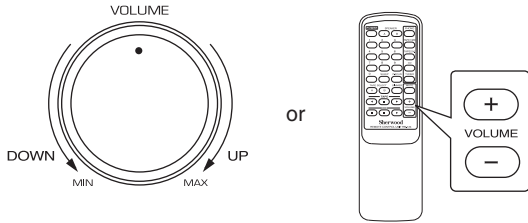

6. Adjust the tone (bass and treble).

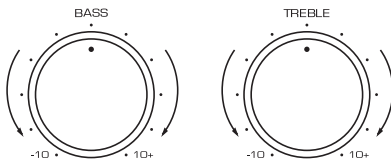

■ **Note** : Extreme settings at high volume may damage your speakers.

7. Adjust the stereo balance between left and right speakers.

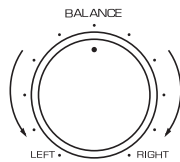

8. To emphasize the sound of frequencies that are difficult to hear at low volume levels.

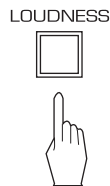

• To cancel the loudness effect, press this switch again.

9. To listen to a program source without the tone effect.

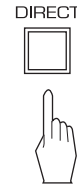

- You can listen to pure sound that bypasses the tone circuitry.
- To cancel the tone direct function, press this switch again.

10. To mute the sound temporarily.

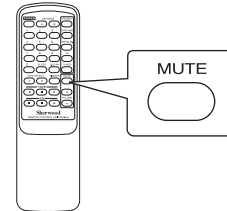

- To resume the previous sound level, press this button again.

11. To listen with the headphones.



- Ensure that both SPEAKER SELECTOR A and B buttons are set to off.

■ **Note**
 • Be careful not to set the volume too high when using headphones.

RECORDING

- The volume and tone (bass, treble) settings, etc. have no effect on the recording signals.

Recording with TAPE 1/MD

1. Select the desired input as recording source except for TAPE 1/MD and TAPE 2 MONITOR.

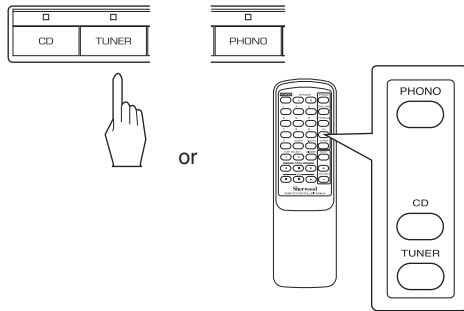

- Be sure that the TAPE 2 MONITOR indicator goes off.

2. Start recording on the tape deck or the MD recorder connected to TAPE 1/MD.

3. Start play on the desired input.

Recording with TAPE 2 MONITOR

1. Select the desired input as recording source except for TAPE 2 MONITOR.

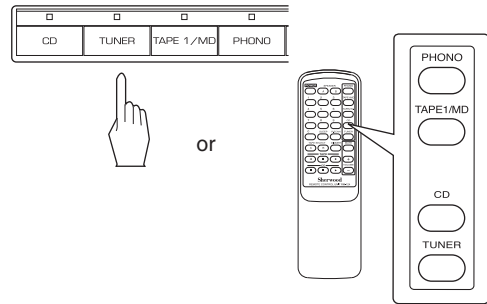

2. Set the TAPE 2 MONITOR button to on.

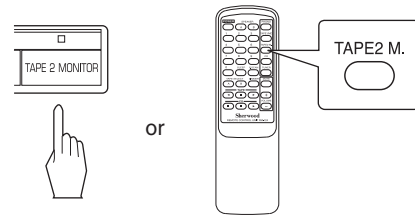

3. Start recording on the tape deck connected to TAPE 2 MONITOR.

4. Start play on the desired input.

- When the TAPE 1/MD is selected as recording sources, dubbing will start from TAPE 1/MD to TAPE 2 MONITOR.
- It is not possible to dub from TAPE 2 MONITOR to TAPE 1/MD.
- For tape monitor function, refer to "TAPE MONITOR function" on page 9.

Troubleshooting Guide

If your unit should not perform as expected, consult the table below to see if the problem can be corrected before seeking help from your dealer or our service organization.

PROBLEM	POSSIBLE CAUSE	REMEDY
No power	<ul style="list-style-type: none"> • The AC input cord is disconnected • Poor connection at AC wall outlet or the outlet is inactive. 	<ul style="list-style-type: none"> • Connect the cord securely. • Check the outlet using a lamp or another appliance.
No sound	<ul style="list-style-type: none"> • Speaker cords are disconnected. • Both SPEAKER SELECTOR A and B buttons are set to off. • The volume is adjusted too low. • The MUTE button on the remote control is pressed to ON. • Incorrect selection of input source. • Incorrect connections between the components. 	<ul style="list-style-type: none"> • Check the speaker connections. • Switch the desired speakers on. • Adjust the volume. • Press the MUTE button to cancel the muting effect. • Select the desired input source correctly. • Make connections correctly.
No recording	<ul style="list-style-type: none"> • Incorrect connections. • Incorrect operation of the tape deck (or MD recorder). 	<ul style="list-style-type: none"> • Make connections correctly. • Operate the tape deck (or MD recorder) correctly.

Specifications

ENGLISH

- Power output, 8 Ω , THD 0.3 %, 40 Hz~20 kHz | **2 X 100 W**
- Total harmonic distortion, 8 Ω , 100 W, 1 kHz | **0.02 %**
- Intermodulation distortion
60 Hz : 7 kHz = 4 : 1 SMPTE, 8 Ω , 100 W | **0.05 %**
- Input sensitivity, 47 k Ω
PHONO (MM) | **3.0 mV**
CD, TUNER, TAPE | **200 mV**
- Phono input overload, THD 0.5 %, 1 kHz | **110 mV**
- Signal to noise ratio, unweighted
PHONO (MM) | **80 dB**
CD, TUNER, TAPE | **95 dB**
- Frequency response
PHONO (MM), RIAA, 40 Hz~20 kHz | **± 1 dB**
CD, TUNER, TAPE, 10 Hz~70 kHz | **+0 dB, -3 dB**
- Crosstalk, 1 kHz, 50 W
TAPE to CD | **75 dB**
CD to TAPE | **75 dB**
- Bass/Treble control, 100 Hz/10 kHz | **± 10 dB**
- Loudness contour, 100 Hz/10 kHz | **+6 dB / +3 dB**

■ GENERAL

- Power supply | **230 V~50 Hz**
- Power consumption | **190 W**
- AC outlet
Switched | **TOTAL 100 W(0.43A) max.**
- Dimensions (W X H X D, including protruding parts) | **440 X 145 X 403 mm (17-3/8 X 5-3/4 X 15-7/8 inches)**
- Weight (Net) | **8.75 kg (19.3 lbs)**

Note : Design and specifications are subject to change without notice for improvements.

AX-5505

Stereo Integrated Amplifier
Amplificateur intégré stéréophonique
Stereo-Vollverstärker
Amplificatore Integrato Stereo
Amplificador Integrado Estéreo

 **Sherwood**