

Pioneer

Operating Instructions

Stereo Receiver

SX-20-K/S

IMPORTANT



The lightning flash with arrowhead symbol, within an equilateral triangle, is intended to alert the user to the presence of uninsulated "dangerous voltage" within the product's enclosure that may be of sufficient magnitude to constitute a risk of electric shock to persons.

CAUTION

**RISK OF ELECTRIC SHOCK
DO NOT OPEN**

CAUTION:
TO PREVENT THE RISK OF ELECTRIC SHOCK, DO NOT REMOVE COVER (OR BACK). NO USER-SERVICEABLE PARTS INSIDE. REFER SERVICING TO QUALIFIED SERVICE PERSONNEL.



The exclamation point within an equilateral triangle is intended to alert the user to the presence of important operating and maintenance (servicing) instructions in the literature accompanying the appliance.

D3-4-2-1-1_A1_En

WARNING

This equipment is not waterproof. To prevent a fire or shock hazard, do not place any container filled with liquid near this equipment (such as a vase or flower pot) or expose it to dripping, splashing, rain or moisture.

D3-4-2-1-3_A1_En

WARNING

Before plugging in for the first time, read the following section carefully.

The voltage of the available power supply differs according to country or region. Be sure that the power supply voltage of the area where this unit will be used meets the required voltage (e.g., 230 V or 120 V) written on the rear panel.

D3-4-2-1-4*_A1_En

WARNING

To prevent a fire hazard, do not place any naked flame sources (such as a lighted candle) on the equipment.

D3-4-2-1-7a_A1_En

Operating Environment

Operating environment temperature and humidity:
+5 °C to +35 °C (+41 °F to +95 °F); less than 85 %RH (cooling vents not blocked)

Do not install this unit in a poorly ventilated area, or in locations exposed to high humidity or direct sunlight (or strong artificial light)

D3-4-2-1-7c*_A1_En

WARNING

Store small parts out of the reach of children and infants. If accidentally swallowed, contact a doctor immediately.

D41-6-4_A1_En

Information for users on collection and disposal of old equipment and used batteries

(Symbol for equipment)



These symbols on the products, packaging, and/or accompanying documents mean that used electrical and electronic products and batteries should not be mixed with general household waste.

For proper treatment, recovery and recycling of old products and used batteries, please take them to applicable collection points in accordance with your national legislation.

By disposing of these products and batteries correctly, you will help to save valuable resources and prevent any potential negative effects on human health and the environment which could otherwise arise from inappropriate waste handling.

For more information about collection and recycling of old products and batteries, please contact your local municipality, your waste disposal service or the point of sale where you purchased the items.

These symbols are only valid in the European Union.

For countries outside the European Union:

If you wish to discard these items, please contact your local authorities or dealer and ask for the correct method of disposal.

K058a_A1_En

(Symbol examples for batteries)



Pb

VENTILATION CAUTION

When installing this unit, make sure to leave space around the unit for ventilation to improve heat radiation (at least 40 cm at top, 10 cm at rear, and 20 cm at each side).

WARNING

Slots and openings in the cabinet are provided for ventilation to ensure reliable operation of the product, and to protect it from overheating. To prevent fire hazard, the openings should never be blocked or covered with items (such as newspapers, table-cloths, curtains) or by operating the equipment on thick carpet or a bed.

D3-4-2-1-7b*_A1_En



POWER-CORD CAUTION

Handle the power cord by the plug. Do not pull out the plug by tugging the cord and never touch the power cord when your hands are wet as this could cause a short circuit or electric shock. Do not place the unit, a piece of furniture, etc., on the power cord, or pinch the cord. Never make a knot in the cord or tie it with other cords. The power cords should be routed such that they are not likely to be stepped on. A damaged power cord can cause a fire or give you an electrical shock. Check the power cord once in a while. When you find it damaged, ask your nearest PIONEER authorized service center or your dealer for a replacement.

5002*_A1_En

If the AC plug of this unit does not match the AC outlet you want to use, the plug must be removed and appropriate one fitted. Replacement and mounting of an AC plug on the power supply cord of this unit should be performed only by qualified service personnel. If connected to an AC outlet, the cut-off plug can cause severe electrical shock. Make sure it is properly disposed of after removal. The equipment should be disconnected by removing the mains plug from the wall socket when left unused for a long period of time (for example, when on vacation).

D3-4-2-2-1a*_A1_En

CAUTION

The ϕ /I **STANDBY/ON** switch on this unit will not completely shut off all power from the AC outlet. Since the power cord serves as the main disconnect device for the unit, you will need to unplug it from the AC outlet to shut down all power. Therefore, make sure the unit has been installed so that the power cord can be easily unplugged from the AC outlet in case of an accident. To avoid fire hazard, the power cord should also be unplugged from the AC outlet when left unused for a long period of time (for example, when on vacation).

D3-4-2-2-2a*_A1_En

This product is for general household purposes. Any failure due to use for other than household purposes (such as long-term use for business purposes in a restaurant or use in a car or ship) and which requires repair will be charged for even during the warranty period.

K041_A1_En

Thank you for buying this Pioneer product.

Please read through these operating instructions so that you will know how to operate your model properly.

Contents

01 Before you start

What's in the box.....	4
Loading the batteries in the remote control.....	4
Installing the receiver.....	4

02 Connecting up

Making cable connections.....	5
Connecting speaker cables.....	5
Connecting antennas.....	6
Plugging in.....	6

03 Controls and displays

Rear panel.....	7
Front panel.....	7
Remote control.....	8

04 Operation

Playback.....	9
Making an audio recording.....	9
Listening to the radio.....	10
An introduction to RDS.....	11
Sound settings.....	11
Switching the desired speakers on.....	12
To set for automatic standby status (Auto Power Down).....	12
Restoring all the settings to the factory default settings.....	12

05 Additional information

Troubleshooting.....	13
Cleaning the unit.....	13
Specifications.....	14

Chapter 1: Before you start

What's in the box

Please confirm that the following accessories are in the box when you open it.

- Remote control
- AAA/IEC R03 dry cell batteries x2
- AM loop antenna
- FM wire antenna
- Power cord
- Warranty card
- Quick start guide
- Safety Brochure
- These operating instructions (CD-ROM)



Note

- Illustrations featured in the Operating Instructions may have been modified or simplified for ease of explanation, and may therefore differ from the actual product appearance.
- The illustrations used here are mainly of the SX-20-S (Silver) model.

Loading the batteries in the remote control

1 Open the rear lid.

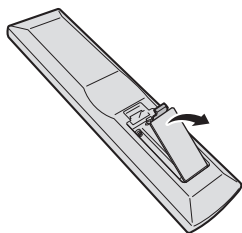

2 Insert the new batteries, matching the polarities as indicated inside the case.

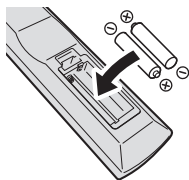

3 Close the rear lid.

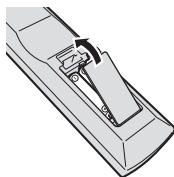

The batteries included with the unit have been provided to allow you check product operation and may not last long. We recommend using alkaline batteries that have a longer life.



WARNING

- Do not use or store batteries in direct sunlight or other excessively hot place, such as inside a car or near a heater. This can cause batteries to leak, overheat, explode or catch fire. It can also reduce the life or performance of batteries.



CAUTION

Incorrect use of batteries may result in such hazards as leakage and bursting. Observe the following precautions:

- When inserting the batteries, make sure not to damage the springs on the battery's \ominus terminals. This can cause batteries to leak or overheat.

- Do not use any batteries other than the ones specified. Also, do not use a new battery together with an old one.
- When loading the batteries into the remote control, set them in the proper direction, as indicated by the polarity marks (\oplus and \ominus).
- Do not heat batteries, disassemble them, or throw them into flames or water.
- Batteries may have different voltages, even if they are the same size and shape. Do not use different types of batteries together.
- To prevent leakage of battery fluid, remove the batteries if you do not plan to use the remote control for a long period of time (1 month or more). If the fluid should leak, wipe it carefully off the inside of the case, then insert new batteries. If a battery should leak and the fluid should get on your skin, flush it off with large quantities of water.
- When disposing of used batteries, please comply with governmental regulations or environmental public institution's rules that apply in your country/area.

Using the remote control

The remote has a range of about 7 m at an angle of about 30° from the remote sensor.

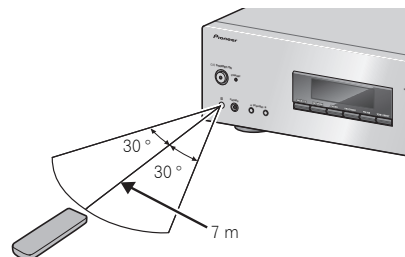

Keep in mind the following when using the remote control:

- Make sure that there are no obstacles between the remote and the remote sensor on the unit.
- Remote operation may become unreliable if strong sunlight or fluorescent light is shining on the unit's remote sensor.
- Remote controllers for different devices can interfere with each other. Avoid using remotes for other equipment located close to this unit.
- Replace the batteries when you notice a fall off in the operating range of the remote.

Installing the receiver

When installing this unit, make sure to put it on a level and stable surface.

- Don't install it on the following places:
 - on a color TV (the screen may distort)
 - near a cassette deck (or close to a device that gives off a magnetic field). This may interfere with the sound.
 - in direct sunlight
 - in damp or wet areas
 - in extremely hot or cold areas
 - in places where there is vibration or other movement
 - in places that are very dusty
 - in places that have hot fumes or oils (such as a kitchen)
- Do not mount the unit on a sofa or other object or material with absorbent qualities, since sound quality may be adversely affected.

Chapter 2: Connecting up

Making cable connections

CAUTION

- Before making or changing the connections, switch off the power and disconnect the power cord from the AC outlet.
- Connect the power cord after all the connections between devices have been completed.

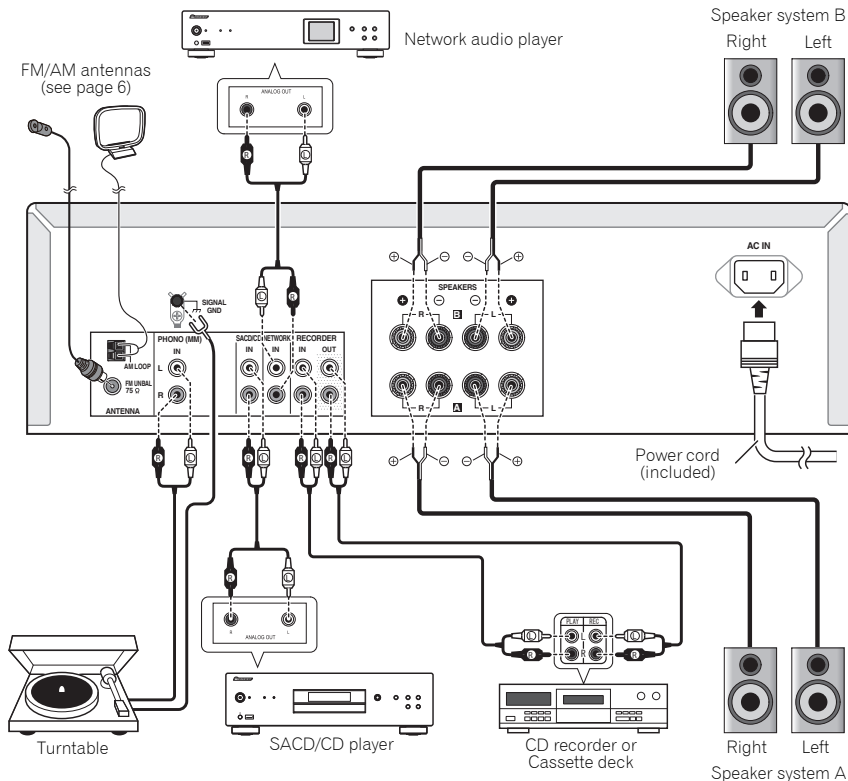

Important

- The **SIGNAL GND** terminal is provided to reduce noise when connecting the unit to components such as an analog turntable.
- Do not connect the **PHONO (MM)** terminals to any component other than a turntable; also, do not connect to a turntable equipped with built-in equalizer. An excessively high sound output may be produced, resulting in damage to your speakers or other devices.
- The unit's **PHONO (MM)** terminals are designed to be used with turntables equipped with MM (moving-magnet) type cartridges. Turntables equipped with MC (moving-coil) cartridges cannot be used.
- Make sure not to bend the cables over the top of this unit (as shown in the illustration). If this happens, the magnetic field produced by the transformers in this unit may cause a humming noise from the speakers.

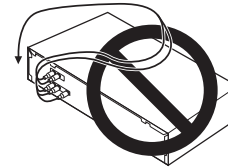

- If your turntable has a grounding wire, secure it to the ground terminal on this receiver.

Note

- When connecting a tape cassette deck, playback noise may be heard, depending on the installation location. This noise is caused by leakage flux from the receiver's transformer. In this event, change the installation location, or move the deck farther from the receiver.

Connecting audio cables

Connect the white plug to the left (L) jack, and the red plug to the right (R) jack. Be sure to insert the plugs fully into the jacks.

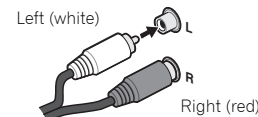

Connecting speaker cables

- 1 Twist the cable cores.
- 2 Loosen the nut on the **SPEAKERS** terminal, and insert the speaker cable into the exposed hole in the terminal shaft.
- 3 Retighten the terminal nut.

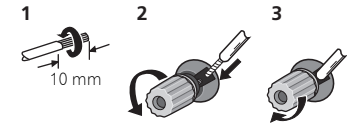

CAUTION

- When using only one set of speaker terminals (**SPEAKERS A** or **SPEAKERS B**), the speaker used should have a nominal impedance between 4 Ω and 16 Ω. When using both sets of terminals, the connected speakers should have nominal impedance between 8 Ω and 16 Ω. Consult the instructions accompanying your speakers for details regarding the impedance value.
- Make sure the positive and negative (+/-) terminals on the receiver match those on the speakers.
- These speaker terminals carry **HAZARDOUS live voltage**. To prevent the risk of electric shock when connecting or disconnecting the speaker cables, disconnect the power cord before touching any uninsulated parts.
- Make sure that all the bare speaker wire is twisted together and inserted fully into the speaker terminal. If any of the bare speaker wire touches the back panel it may cause the power to cut off as a safety measure.

Connecting antennas

Connect the AM loop antenna and the FM wire antenna as shown below. To improve reception and sound quality, connect external antennas (see *Using external antennas* below).

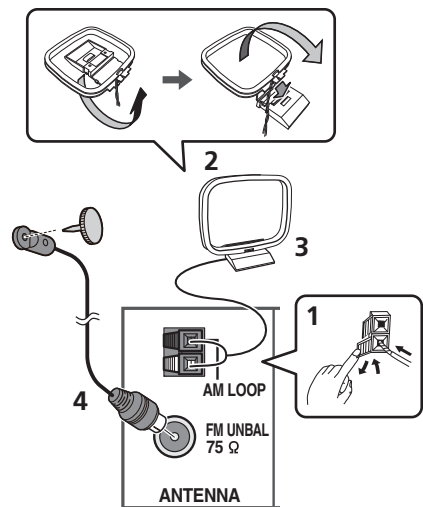

1 Push open the tabs, then insert one wire fully into each terminal, then release the tabs to secure the AM antenna wires.

2 Fix the AM loop antenna to the attached stand.

To fix the stand to the antenna, bend in the direction indicated by the arrow then clip the loop onto the stand.

3 Place the AM antenna on a flat surface and in a direction giving the best reception.

4 Connect the FM wire antenna into the FM antenna socket.

For best results, extend the FM antenna fully and fix to a wall or door frame. Don't drape loosely or leave coiled up.

Using external antennas

To improve FM reception

Use a PAL connector (not supplied) to connect an external FM antenna.

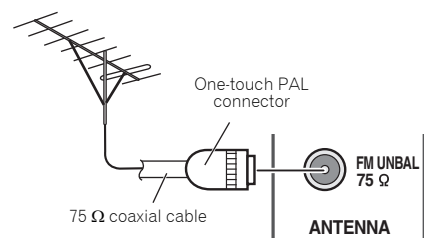

To improve AM reception

Connect a 5 m to 6 m length of vinyl-coated wire to the AM antenna terminal without disconnecting the supplied AM loop antenna.

For the best possible reception, suspend horizontally outdoors.

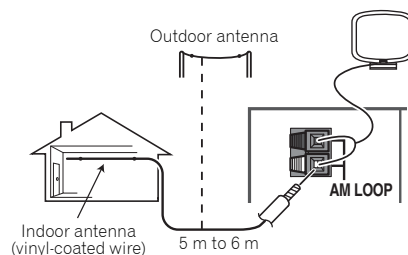

Plugging in

CAUTION

- Do not use any power cord other than the one supplied with this unit.
- Do not use the supplied power cord for any purpose other than that described below.

Important

- When going on a trip or otherwise not using the unit for an extended period, always disconnect the power cord from its outlet. Note that various internal settings will not be lost even if the power cord is disconnected from its outlet for an extended time.
- If it is necessary to detach the power cord, first be sure to press **⏻/STANDBY/ON** on the front panel so receiver is turned OFF.

After you've finished making all connections, plug the unit into an AC outlet.

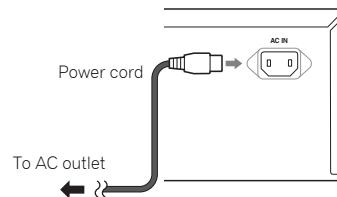

1 Plug the supplied power cord into the AC IN socket on the rear panel of the unit.

2 Plug the other end into an AC outlet.

Chapter 3: Controls and displays

Rear panel

See pages 5-6 for details regarding connections.

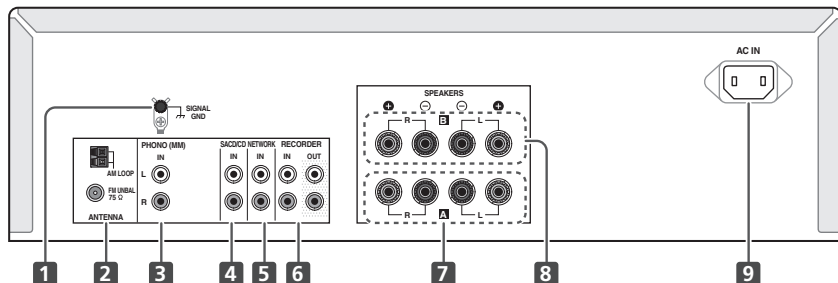

1 SIGNAL GND (Turntable ground) terminal

This ground terminal is designed to help reduce noise when a turntable is connected. It is not a safety ground.

2 ANTENNA terminal

Connect supplied FM wire antenna and AM loop antenna.

3 PHONO (MM) IN terminals

4 SACD IN terminals

5 NETWORK IN terminals

6 RECORDER IN/OUT terminals

7 SPEAKERS A terminals

8 SPEAKERS B terminals

9 AC IN jack

Connect power cord to here and an AC wall socket.

Front panel

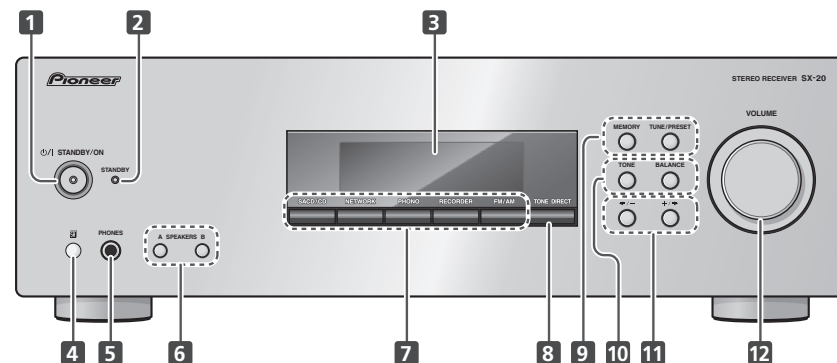

1 **⏻/I STANDBY/ON button**

Switches the receiver between off and on.

When power is turned on, the power indicator in the center of the button will light blue.

2 **STANDBY indicator**

When power is set to standby, the indicator lights red.

3 **Character display**

See *Display* on page 8.

4 **Remote sensor**

Receives the signals from the remote control (page 4).

5 **PHONES jack**

Use to connect headphones. Be sure to switch off both A and B speakers.

6 **SPEAKERS A/B buttons**

These buttons allow you to select various combinations of speakers as follows:

- To drive **A** speakers, press **SPEAKERS A** button (**SPK A** is displayed).
- To drive **B** speakers, press **SPEAKERS B** button (**SPK B** is displayed).
- To drive both **A** and **B** speakers, press **SPEAKERS A** and **B** buttons in order (**SPK A B** is displayed).
- When using headphones for private listening, press these buttons in order to switch off the speakers **A** and **B** (**SPK OFF** is displayed, and **H** indicator lights).

7 **Input function buttons**

Use to select the input source to this receiver (page 9).

8 **TONE DIRECT button**

Press to select the TONE DIRECT mode (page 12).

9 **Tuner control buttons**

MEMORY – Press to store preset stations.

TUNE/PRESET – Press to select the tuning mode or the preset mode.

10 **Sound control buttons**

TONE – When adjusting the tone (bass and treble), press to select the desired tone mode.

- Each time this button is pressed, the tone mode is changed to bass or treble.

BALANCE – When adjusting the sound volume balance, press to enter the balance mode.

11 **←/– and +/→ buttons**

At the tuning mode, use to find radio frequencies.

At the preset mode, use to select preset radio stations. Also used when setting up the receiver.

12 **VOLUME control**

Use to adjust the volume level. (Also allows adjustment of the headphone sound volume.)

Display

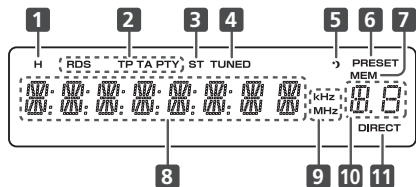
**1 H (Headphones)**

Lights when both speakers **A** and **B** are switched off.

2 RDS indicators

Lights when an RDS broadcast is received.

3 ST

Lights when a stereo FM broadcast is being received in stereo mode.

4 TUNED

Lights when a normal broadcast channel.

5 Sleep timer indicator

Lights when the receiver is in sleep mode.

6 PRESET

Lights when the tuner preset mode is selected.

7 MEM

Blinks when a radio station is registered.

8 Character display

Displays various system information.

9 kHz/MHz

Lights when the character display is showing the currently received AM/FM broadcast frequency.

10 Preset information

Shows the preset number of the tuner.

11 DIRECT

Lights when the **TONE DIRECT** mode is switched on.

Remote control

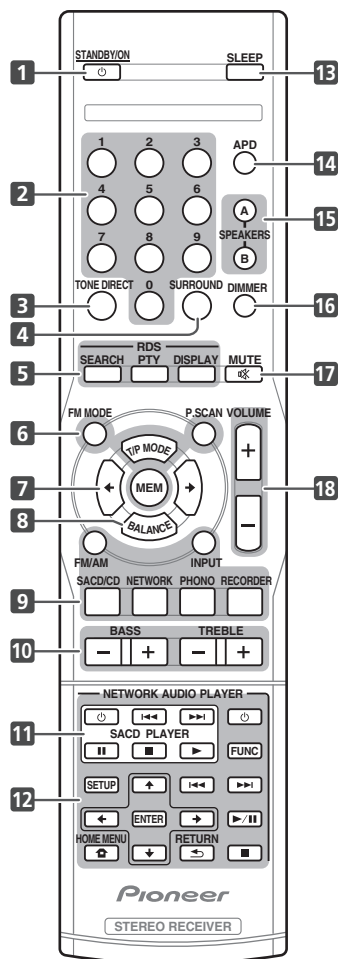
**1 STANDBY/ON**

Switches the receiver between standby and on.

2 Numeric buttons (0 ~ 9)

Press to select or to store preset.

3 TONE DIRECT

Press to select the **TONE DIRECT** mode (page 12).

4 SURROUND

Press to select the surround sound options (page 12).

5 RDS control buttons

SEARCH – Use to select the search mode (page 11).

PTY – Use to search for RDS program types (page 11).

DISPLAY – Use to display the RDS information (page 11).

6 Tuner control buttons

FM MODE – Press to select the desired FM mode (Stereo or monaural) (page 10).

P.SCAN – Press to scan the stations in the preset sequence (page 10).

T/P MODE – Press to select the tuning mode or the preset mode (page 10).

MEM – Press to store preset stations (page 10).

7 ←/→

At the tuning mode, use to find radio frequencies.

At the preset mode, use to select preset radio stations. Also used when setting up the receiver.

8 BALANCE

When adjusting the sound volume balance, press to enter the balance mode (page 11).

9 Input function buttons

Press to select an input source. These select the component connected to the corresponding input on the rear panel.

INPUT – Press repeatedly to select desired input function. Use to change the input source. The source changes as below.

SACD/CD → NETWORK → PHONO → RECORDER → FM/AM → Return to the beginning.

10 Tone control buttons

BASS +/- – Use to adjust Bass (page 11).

TREBLE +/- – Use to adjust Treble (page 11).

11 SACD PLAYER control buttons

Use to control Pioneer SACD/CD player.

12 NETWORK AUDIO PLAYER control buttons

Use to control Pioneer network audio player.

13 SLEEP

Press to change the amount of time before the receiver switches into standby (10 min – 20 min – 30 min – 60 min – 90 min – Off). You can check the remaining sleep time at any time by pressing **SLEEP** once.

14 APD

Use to change the Auto Power Down function setting (page 12).

15 SPEAKERS A/B buttons

These buttons allow you to select various combinations of speakers as follows:

- To drive **A** speakers, press **SPEAKERS A** button (**SPK A** is displayed).
- To drive **B** speakers, press **SPEAKERS B** button (**SPK B** is displayed).
- To drive both **A** and **B** speakers, press **SPEAKERS A** and **B** buttons in order (**SPK A B** is displayed).
- When using headphones for private listening, press these buttons in order to switch off the speakers **A** and **B** (**SPK OFF** is displayed, and **H** indicator lights).

16 DIMMER

Dims or brightens the display. The brightness can be controlled in four steps.

17 MUTE

Mutes/unmutes the sound.

18 VOLUME +/-

Use to set the listening volume.

Chapter 4: Operation

Playback

- To listen to the FM/AM radio broadcasts, see page 10.

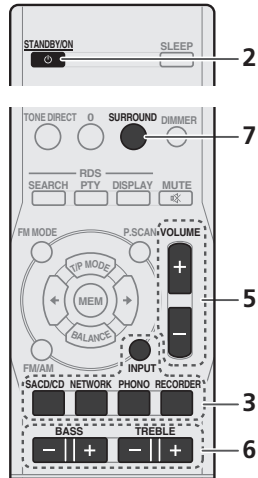
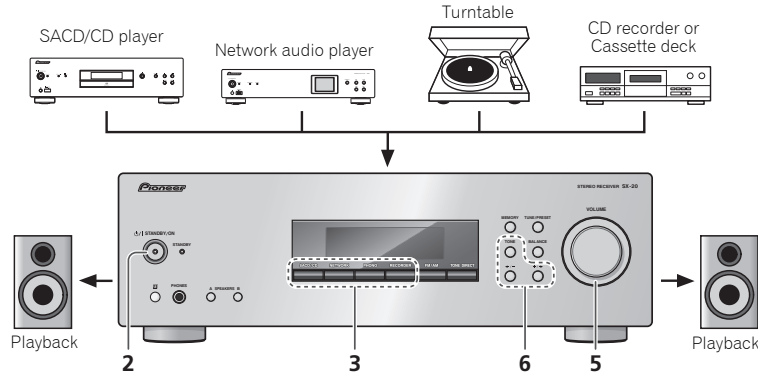

- Turn on the power of the playback component.
- Turn power ON to the unit.
 - If the unit is in the standby mode, press the remote control's **STANDBY/ON** button.
- Select the source you want to playback. Select the playback component.
 - When using the remote control, the **INPUT** button can be used to select the component.
- Start playback of the component you selected in step 1.
- Adjust playback volume with **VOLUME** control.
- Adjust the tone to your preference using the **TONE (BASS and TREBLE)** controls.
- Select a surround mode you want.

Set the power to Standby

- Press the remote control's **STANDBY/ON** button.

The next time you wish to turn on the power, press the remote control's **STANDBY/ON** button.

- If the front panel's **STANDBY/ON** button is pressed, the power will be turned off. In this case, if the power is off, pressing the remote control's **STANDBY/ON** button will not turn on the power. To turn on the power again, press the front panel's **STANDBY/ON** button.

Note

- If the power cord is disconnected when the unit is in the standby mode the unit will turn off, but when the cord is then reconnected, the unit will not automatically turn on. After reconnecting the power cord, press the remote control's **STANDBY/ON** button to turn the power on.

Making an audio recording

You can make an audio recording from any audio source connected to the receiver.

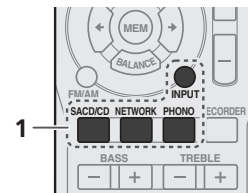
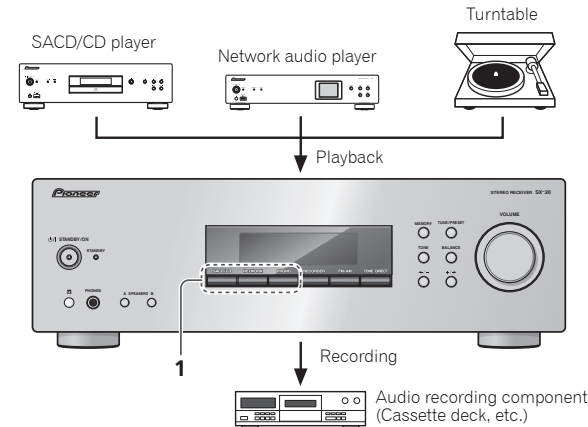

- Select the source you want to record.
- Start recording, then start playback of the source component.

Listening to the radio

The following steps show you how to tune in to FM and AM radio broadcasts using the automatic (search) and manual (step) tuning functions. Once you are tuned to a station you can memorize the frequency for recall later—see *Saving station presets* below for more on how to do this.

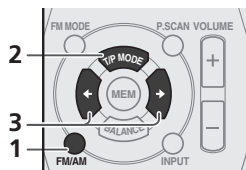

1 Press FM/AM repeatedly to select the band (FM or AM).

2 Press T/P MODE to change to tuning mode.

PRESET indicator goes off.

3 Tune to a station.

There are three ways to do this:

◆Automatic tuning

To search for stations in the currently selected band, press and hold \leftarrow/\rightarrow for about 0.5 second. The receiver will start searching for the next station, stopping when it has found one. Repeat to search for other stations.

◆Manual tuning

To change the frequency one step at a time, press \leftarrow/\rightarrow .

◆High speed tuning

Press and hold \leftarrow/\rightarrow for high speed tuning.

Improving FM sound

When FM stereo broadcasts are poor because of weak broadcast signals, select the **FM MONO** mode to reduce the noise, then FM broadcasts are reproduced in monaural sound.

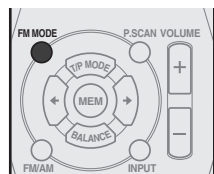

1 Press FM MODE to select "FM MONO".

Saving station presets

If you often listen to a particular radio station, it's convenient to have the receiver store the frequency for easy recall whenever you want to listen to that station. This saves the effort of manually tuning in each time. This unit can memorize up to 30 stations.

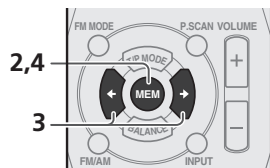

1 Tune to a station you want to memorize.

See *Listening to the radio* above for more on this.

2 Press MEM.

MEM indicator is blinking.

3 Within 5 seconds, press \leftarrow/\rightarrow to select the station preset you want.

You can also use the numeric buttons.

Examples:

For "2": Press "2".

For "17": Press "1", then press "7" within 2 seconds.

For "30": Press "0".

- When using the numeric buttons, the station is stored automatically without pressing **MEM** in step 4.
- A stored frequency is erased from the memory by storing another frequency in its place.
- If **MEM** indicator goes off, start again from the above step 2.

4 Press MEM.

MEM indicator stop blinking and the receiver stores the station.

Listening to station presets

You will need to have some presets stored to do this. See *Saving station presets* above if you haven't done this already.

1 Press T/P MODE to change to preset mode.

PRESET indicator lights up.

2 Press \leftarrow/\rightarrow to select the station preset you want.

- You can also use the numeric buttons on the remote control to recall the station preset.

Scanning preset stations in sequence

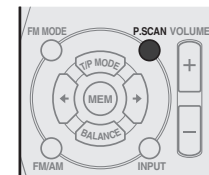

1 Press P.SCAN.

The receiver will start scanning the stations in the preset sequence.

- At the desired station, press this button again to stop scanning.

An introduction to RDS

Radio Data System (RDS) is a system used by most FM radio stations to provide listeners with various kinds of information—the name of the station and the kind of show they're broadcasting, for example.

One feature of RDS is that you can search by type of program. For example, you can search for a station that's broadcasting a show with the program type, **JAZZ**.

You can search the following program types:

- NEWS** – News
- AFFAIRS** – Current Affairs
- INFO** – General Information
- SPORT** – Sport
- EDUCATE** – Educational
- DRAMA** – Radio plays, etc.
- CULTURE** – National or regional culture, theater, etc.
- SCIENCE** – Science and technology
- VARIED** – Usually talk-based material, such as quiz shows or interviews.
- POP M** – Pop music
- ROCK M** – Rock music
- EASY M** – Easy listening
- LIGHT M** – 'Light' classical music
- CLASSICS** – 'Serious' classical music
- OTHER M** – Music not fitting above categories
- WEATHER** – Weather reports
- FINANCE** – Stock market reports, commerce, trading, etc.
- CHILDREN** – Programs for children
- SOCIAL** – Social affairs
- RELIGION** – Programs concerning religion
- PHONE IN** – Public expressing their views by phone
- TRAVEL** – Holiday-type travel rather than traffic announcements
- LEISURE** – Leisure interests and hobbies
- JAZZ** – Jazz
- COUNTRY** – Country music
- NATION M** – Popular music in a language other than English
- OLDIES** – Popular music from the '50s and '60s
- FOLK M** – Folk music
- DOCUMENT** – Documentary
 - In addition, there are three other program types, **TEST**, **ALARM** and **NONE**. **TEST** and **ALARM** are used for emergency announcements. **NONE** appears when a program type cannot be found.

Searching for RDS programs

There are three ways of search for RDS programs as follows.

- **RDS search** – Use to automatically search and receive the stations offering RDS services.
- **TP search** – Use to automatically search and receive the stations broadcasting the traffic program.
- **PTY search** – Use to automatically search and receive the stations broadcasting the desired program type.

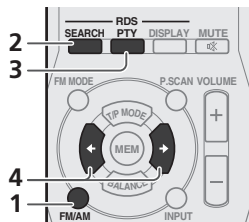

1 Press FM/AM repeatedly to select the FM band.

- RDS is only possible in the FM band.

2 Press RDS SEARCH to select the search mode you want.

The search mode changes as follows;

- RDS SRCH RDS search
- ↓
- TP SRCH TP (Traffic Program) search
- ↓
- PTY SRCH PTY (Program Type) search
- ↓
- OFF Off
- (RDS SRCH)

3 When the PTY search mode is selected, press RDS PTY to select the program type you want to hear.

4 Press ←/→ to search the station.

The system starts searching through the station presets for a match, stopping when it was found one. Repeat to search for other stations.

- **NO RDS** is displayed if no other RDS station is found.
- **NO TRAFF** is displayed if the signal is too weak or there are no stations broadcasting the traffic program.
- If **NO PROG** is displayed it means the tuner couldn't find that program type at the time of the search.

Displaying RDS information

Use the **RDS DISPLAY** button to display the different types of RDS information available.



1 Press RDS DISPLAY for RDS information.

Each press changes the display as follows:

- Current tuner frequency
- Program Service Name (**PS**) – The name of the radio station.
- Program Type (**PTY**) – This indicates the kind of program currently being broadcast.
- Clock Time (**CT**)
- Radio Text (**RT**) – Messages sent by the radio station. For example, a talk radio station may provide a phone number as RT.

Note

- If any noise is picked up while displaying the RT scroll, some characters may be displayed incorrectly.
- If the signals are too weak or no RDS service is available, **NO NAME**, **NO PTY**, **NO TIME** or **NO TEXT** will be displayed.

Sound settings

Adjusting the bass and treble

Use the bass and treble controls to adjust the overall tone.

1 Use BASS +/- or TREBLE +/- on the remote control to adjust bass or treble.

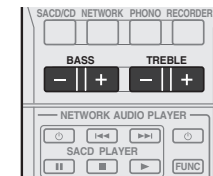

Note

- You can also use the front panel controls. Press **TONE** repeatedly to select **BASS** or **TREBLE**, then press ←/– or +/→ to adjust the bass or treble as desired.

Adjusting the sound volume balance

Adjust the sound volume balance between the left and right speakers.

1 Press BALANCE then press ←/→ (←/– or +/→) to adjust the sound volume balance.

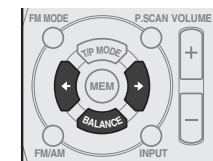

Listening in surround sound

Allows you to create natural surround sound effects using just the left and right speakers.

- Default setting: OFF

1 Press SURROUND repeatedly to select the surround sound options.

- You can select **MIN**, **MID**, **MAX** or **OFF**. If set to **MAX**, the surround sound effects will be more emphasized.

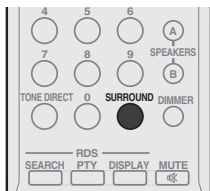

Note

- Depending on the sound source, in some cases it may not be possible to achieve good results. In this case, set the setting to **OFF**.

Using Tone Direct

Use the Tone Direct modes when you want to hear the truest possible reproduction of a source.

1 Press TONE DIRECT to switch the DIR (Direct mode ON) or CTRL (Direct mode OFF).

When **DIR** is selected, independent tone settings (Bass/Treble), Balance, Surround sound are disabled. In addition, **DIRECT** lights up and the front panel's display will be turned off.

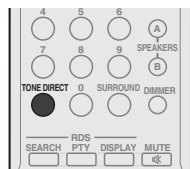

Switching the desired speakers on

Then the corresponding speaker indication (**SPK A** (and/or) **B**) is displayed and the sound can be heard from the speakers connected to the selected speaker terminals.

1 Use SPEAKERS A/B buttons to listen to the speaker system connected to SPEAKERS A or B terminals.

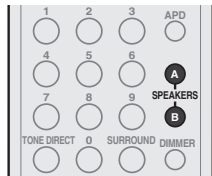

Note

- When using the headphones for private listening, press the corresponding **SPEAKERS A/B** buttons to switch off both **A** and **B** speakers.

To set for automatic standby status (Auto Power Down)

Set to automatically turn off the receiver after a specified time has passed (when the power has been on with no operation for several hours).

- Default setting: 6H

1 Press APD repeatedly to specify the amount of time to allow before the power is turned off (when there has been no operation).

- You can select 2, 4 or 6 hours, or **OFF** (if no automatic shutoff is desired).



Note

- You can check the Auto Power Down setting at any time by pressing **APD** once.

Restoring all the settings to the factory default settings

Use this procedure to reset all the receiver's settings to the factory default. Use the front panel controls to do this.

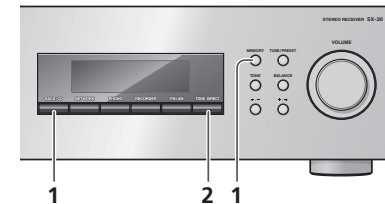

1 When power is in standby mode, hold **SLED/CD** button and **MEMORY** button depressed simultaneously for two seconds.

2 When you see "RESET?" appear in the display, press **TONE DIRECT** button. **OK** appears in the display to indicate that the receiver has been reset to the factory default settings.

Chapter 5: Additional information

Troubleshooting

Incorrect operations are often mistaken for trouble and malfunctions. If you think that there is something wrong with this component, check the points below. Sometimes the trouble may lie in another component. Investigate the other components and electrical appliances being used. If the trouble cannot be rectified even after exercising the checks listed below, ask your nearest Pioneer authorized service center or your dealer to carry out repair work.

- If the unit does not operate normally due to external effects such as static electricity disconnect the power plug from the outlet and insert again to return to normal operating conditions.

Problem	Remedy
The power does not turn on.	<ul style="list-style-type: none"> • Is the power plug disconnected from the power outlet? Connect the power plug correctly to its outlet (page 6). • Is the power cord disconnected from the AC IN connector? Connect the power cord correctly (page 6).
Power turns off.	<ul style="list-style-type: none"> • Is the Auto Power Down function turned ON? If you do not want the power to turn off automatically, disable the Auto Power Down function (page 12). • The temperature within the unit has exceeded the allowable value. Try moving the unit for better ventilation (page 3). • Lower the volume level. • After about a minute (you won't be able to switch the unit on during this time), switch the receiver back on. If the message persists, call a Pioneer authorized independent service company.
TEMP shows in the display and the volume level drops.	<ul style="list-style-type: none"> • The temperature within the unit has exceeded the allowable value. Try moving the unit for better ventilation (page 3). • Lower the volume level.
No sound is output when a function is selected.	<ul style="list-style-type: none"> • A connection cable is disconnected or connected improperly. Check your connections (page 5). • Connectors or pin plugs on a cable are dirty. Wipe off any dirt from connectors and pin plugs. • Confirm that the unit's input selector is set to the desired playback component. Set selector correctly (page 9). • Press MUTE on the remote control to turn muting off (page 7).
No sound from one speaker.	<ul style="list-style-type: none"> • Are the connection cables or speaker cables disconnected on one side? Reconnect securely (page 5).
Considerable noise in radio broadcasts.	<ul style="list-style-type: none"> • Connect the antenna (page 6) and adjust the position for best reception. • Route any loose cables away from the antenna terminals and wires. • Fully extend the FM wire antenna, position for best reception, and secure to a wall (or connect an outdoor FM antenna). • Connect an additional internal or external AM antenna (page 6). • Turn off equipment causing interference or move it away from the receiver (or move antennas farther away from equipment causing noise).
Broadcast stations cannot be selected automatically.	<ul style="list-style-type: none"> • Connect an outdoor antenna (page 6).

Problem	Remedy
Noise during playback of a cassette deck.	<ul style="list-style-type: none"> • Move the cassette deck away from your receiver, until the noise disappears.
The display is dark or off.	<ul style="list-style-type: none"> • Press DIMMER on the remote control repeatedly to return to the default. • The front panel display is automatically turned off when the Tone Direct mode is set to DIR (ON). To see the display, press TONE DIRECT and set the function to CTRL (OFF).
Can't operate the remote control.	<ul style="list-style-type: none"> • Replace the battery (page 4). • Operate within 7 m, 30° of the remote sensor on the front panel (page 4). • Remove the obstacle or operate from another position. • Avoid exposing the remote sensor on the front panel to direct light. • Is the control cord for one component connected improperly? Confirm correct connections (page 5).

Cleaning the unit

- Use a polishing cloth or dry cloth to wipe off dust and dirt.
- When the surface is dirty, wipe with a soft cloth dipped in some neutral cleanser diluted five or six times with water, and wrung out well, and then wipe again with a dry cloth. Do not use furniture wax or cleansers.
- Never use thinners, benzene, insecticide sprays or other chemicals on or near this unit, since these will corrode the surface.

Specifications

Amplifier section

Power output specification is for when power supply is 230 V.

- **Continuous power output (both channels driven at 20 Hz to 20 kHz)**
100 W+100 W (THD 1 %, 8 Ω)

Audio section

- **Input (Sensitivity/Impedance)**
SACD/CD 400 mV/47 kΩ
PHONO (MM) 5.5 mV/47 kΩ

- **Output (Level/Impedance)**
RECORDER OUT. 400 mV/2.0 kΩ

- **Frequency response**
SACD/CD, NETWORK, RECORDER
. 5 Hz to 100 kHz ± 3 dB
PHONO (MM) 20 Hz to 20 kHz ± 0.5 dB

- **Tone control (When VOLUME is set to -30 dB)**
Bass ± 14 dB (100 Hz)
Treble ± 14 dB (10 kHz)

- **Signal-to-Noise Ratio (IHF SHORTED, A-NETWORK)**
SACD/CD, NETWORK, RECORDER 100 dB
PHONO (MM, 5.5 mV input) 80 dB

- **Total Harmonic Distortion**
SACD/CD, NETWORK, RECORDER 0.02 % or less
(1 kHz, 50 W, 8 Ω)

- **Speaker load impedance**
A, B. 4 Ω to 16 Ω
A+B. 8 Ω to 16 Ω

Tuner Section

Frequency Range (FM) 87.5 MHz to 108 MHz
Antenna Input (FM) 75 Ω unbalanced
Frequency Range (AM) 531 kHz to 1602 kHz
Antenna (AM) Loop antenna

Miscellaneous

Power requirements AC 220 V to 230 V, 50 Hz/60 Hz
Power consumption 210 W
In standby 0.3 W
Dimensions
. 435 mm (W) x 142.5 mm (H) x 364 mm (D)
Weight (without package) 8.3 kg

Accessories

Remote control 1
AAA/IEC R03 dry cell batteries 2
AM loop antenna 1
FM wire antenna 1
Power cord
Warranty card
Quick start guide
Safety Brochure
These operating instructions (CD-ROM)



Note

- Specifications and the design are subject to possible modifications without notice, due to improvements.
- Corporation and product names mentioned herein are trademarks or registered trademarks of the respective corporations.

Discover the benefits of registering your product online at <http://www.pioneer.co.uk> (or <http://www.pioneer.eu>).

PIONEER CORPORATION

1-1, Shin-ogura, Saiwai-ku, Kawasaki-shi, Kanagawa 212-0031, Japan

PIONEER ELECTRONICS (USA) INC.

P.O. BOX 1540, Long Beach, California 90801-1540, U.S.A. TEL: (800) 421-1404

PIONEER ELECTRONICS OF CANADA, INC.

340 Ferrier Street, Unit 2, Markham, Ontario L3R 2Z5, Canada TEL: 1-877-283-5901, 905-479-4411

PIONEER EUROPE NV

Haven 1087, Keetberglaan 1, B-9120 Melsele, Belgium TEL: 03/570.05.11

PIONEER ELECTRONICS ASIACENTRE PTE. LTD.

253 Alexandra Road, #04-01, Singapore 159936 TEL: 65-6472-7555

PIONEER ELECTRONICS AUSTRALIA PTY. LTD.

5 Arco Lane, Heatherton, Victoria, 3202, Australia, TEL: (03) 9586-6300

PIONEER ELECTRONICS DE MEXICO S.A. DE C.V.

Blvd.Manuel Avila Camacho 138 10 piso Col.Lomas de Chapultepec, Mexico, D.F. 11000 TEL: 55-9178-4270

K002_B3_En

© 2012 PIONEER CORPORATION.

All rights reserved.

<ARB7498-A>