

User Manual

Formovie Theater Premium Laser TV

In order to promote environmental protection and assume social responsibility, we strongly recommend you to acquire the electronic user manual of multi-language through the QR code below.



Get multilingual electronic user manual

Téléchargez le manuel d'utilisation électronique multilingue

Obtenga el manual del usuario electrónico multilingüe

Rufen Sie die mehrsprachige Bedienungsanleitung ab

تأخذ المالدعم يذورتكاللإمدادجستسمالليدد لىلغ لىصحا

多言語電子ユーザーマニュアルを入手してください

獲取多語言版本電子版用戶手冊

다국어 전자 사용 설명서 받기

User Notice

Thank you for choosing Formovie Theater Laser Projector.

Read this manual carefully before use, and retain it for future reference. Illustrations of product, accessories, and user interface in the user manual are for reference purposes only. Actual product and functions may vary due to product enhancements.

Legal Notice



Hereby, [Formovie (Chongqing) Innovative Technology Co., Ltd.] declares that the radio equipment type [Laser Projector / L206FGN-X2] is in compliance with Directive 2014 / 53 / EU and Radio Equipment Regulations 2017. The full text of the declaration of conformity is available at the following internet address:

<http://www.formovie.com/global/service/support/declaration.html>

This device is restricted to indoor use when operating in the 5150 to 5350 MHz frequency range.

BT maximum transmitter power: 100mW at 2.4GHz - 2.4835GHz

Wi-Fi 2.4G maximum transmitter power: 100mW at 2.4GHz - 2.4835GHz

Wi-Fi 5G maximum transmitter power: 200mW at 5.15GHz - 5.25GHz, 100mW at 5.25GHz - 5.35GHz & 5.47GHz - 5.725GHz



All products bearing this symbol are waste electrical and electronic equipment (WEEE as in directive 2012/19/EU) which should not be mixed with unsorted household waste. Instead, you should protect human health and the environment by handing over your waste equipment to a designated collection point for the recycling of waste electrical and electronic equipment, appointed by the government or local authorities. Correct disposal and recycling will help prevent potential negative consequences to the environment and human health. Please contact the installer or local authorities for more information about the location as well as terms and conditions of such collection points.



Correct disposal of the batteries in this product
(Applicable in countries with separate collection systems)

This marking on battery, manual or packaging indicates that the batteries in this product should not be disposed of with other household waste at the end of their working life. Where marked, the chemical symbols Hg, Cd or Pb indicate that the battery contains mercury, cadmium or lead above the reference levels in EC Directive 2006/66. If batteries are not properly disposed of, these substances can cause harm to human health or the environment.

To protect natural resources and to promote material reuse, please separate batteries from other types of waste and recycle them through your local, free battery return system.



This device complies with part 15 of the FCC Rules. Operation is subject to the following two conditions: (1) This device may not cause harmful interference, and (2) this device must accept any interference received, including interference that may cause undesired operation.

Note: This equipment has been tested and found to comply with the limits for a Class B digital device, pursuant to part 15 of the FCC rules. These limits are designed to provide reasonable protection against harmful interference in a residential installation. This equipment generates, uses and can radiate radio frequency energy and, if not installed and used in accordance with the instructions, may cause harmful interference to radio communications. However, there is no guarantee that interference will not occur in a particular installation. If this equipment does cause harmful interference to radio or television reception, which can be determined by turning the equipment off and on, the user is encouraged to try to correct the interference by one or more of the following measures:

- Reorient or relocate the receiving antenna.
- Increase the separation between the equipment and receiver.
- Connect the equipment into an outlet on a circuit different from that to which the receiver is connected.
- Consult the dealer or an experienced radio/TV technician for help.

Important: You are cautioned that changes or modifications not expressly approved by the party responsible for compliance could void the user's authority to operate the equipment.

RF Exposure Information: The radiated output power of this device meets the limits of FCC/IC radio frequency exposure limits. This device should be operated with a minimum separation distance of 20cm (8 inches) between the equipment and a person's body.

RF warning for Portable device: The device has been evaluated to meet general RF exposure requirement. The device can be used in portable exposure condition without restriction.

Canada regulatory compliance

This device complies with Innovation, Science and Economic Development Canada license-exempt RSS standard(s). Operation is subject to the following two conditions: (1) this device may not cause interference, and (2) this device must accept any interference, including interference that may cause undesired operation of the device.

Operation in the band 5150–5250 MHz is only for indoor use to reduce the potential for harmful interference to co-channel mobile satellite systems.

Exposure to radio frequency energy

The radiated output power of this device meets the limits of FCC/IC radio frequency exposure limits. This device should be operated with a minimum separation distance of 20 cm (8 inches) between the equipment and a person's body.

RF warning for Portable device: The device has been evaluated to meet general RF exposure requirement. The device can be used in portable exposure condition without restriction.

CAN ICES-003 (B)/NMB-003(B)

Le présent appareil est conforme aux CNR d'Innovation, Sciences et Développement économique Canada applicables aux appareils radio exempts de licence. L'exploitation est autorisée aux deux conditions suivantes : (1) l'appareil ne doit pas produire de brouillage, et (2) l'utilisateur de l'appareil doit accepter tout brouillage radioélectrique subi, même si le brouillage est susceptible d'en compromettre le fonctionnement.

La bande 5150–5250 MHz est réservée uniquement pour une utilisation à l'intérieur afin de réduire les risques de brouillage préjudiciable aux systèmes de satellites mobiles utilisant les mêmes canaux.

L'exposition à l'énergie radiofréquence

La puissance de sortie rayonnée de cet appareil est conforme aux limites de la FCC/IC limites d'exposition aux fréquences radio. Cet appareil doit être utilisé avec une distance minimale de séparation de 20 cm entre l'appareil et le corps d'une personne.

Avertissement RF pour un appareil portable: L'appareil a été évalué et répond aux exigences générales d'exposition aux RF. L'appareil peut être utilisé dans des conditions d'exposition portables sans restriction.

CAN ICES-003 (B)/NMB-003(B)

Photobiological and Laser Safety Information

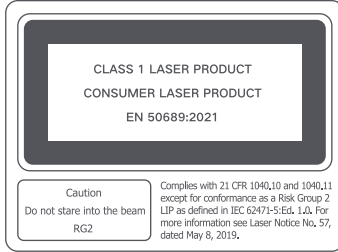

As with any bright light source, do not stare into the beam, RG2 IEC 62471-5:2015

For Europe

The product complies with IEC 60825-1:2014 & EN 50689:2021 Class 1 and RG2 IEC 62471-5:2015.

For U.S.A.

Complies with 21 CFR 1040.10 and 1040.11 except for conformance as a Risk Group 2 LIP as defined in IEC 62471-5:Ed. 1.0. For more information see Laser Notice No. 57, dated May 8, 2019.



CAUTION:

- Notice is given to supervise children and to never allow them to stare into the projector beam at any distance from the projector.
- Notice is given to use caution when using the remote control for starting the projector while in front of the projection lens.
- Notice is given to the user to avoid the use of optical aids such as binoculars or telescopes inside the beam.

Safety Instructions

Before using the product, please carefully read the following safety instructions.

Safety Label Description



This warning symbol informs the user that this product contains non-insulated voltage sources that can cause an electric shock. Coming into contact with any internal component may result in an electric shock.



This symbol informs the user about important handling and maintenance related information. Please read this information carefully to ensure proper use.



This symbol informs the user to be aware of high temperatures.



This symbol informs the user to avoid touching this part.



Grounding Warning: This product must be grounded when in use.



Transportation Instructions: It is recommended to transport this projector in its original or similar packaging.



CAUTION:

- Risk of explosion if the battery is replaced by an incorrect type.
- Disposal of a battery into fire or a hot oven, or mechanically crushing or cutting of a battery, that can result in an explosion.
- Leaving a battery in an extremely high temperature surrounding environment that can result in an explosion or the leakage of flammable liquid or gas.
- A battery subjected to extremely low air pressure that may result in an explosion or the leakage of flammable liquid or gas.



Preventing Electric Shocks and Fire Hazards

- Using an incorrect power cord may result in decreased product performance and even electric shock or fire. To ensure the projector's performance and safety, only use its original power cord or an identical replacement.
- If you use an extension cord, it must not have a current rating lower than the projector's original power cord. Failure to heed this warning may result in the extension cord overheating and could pose hazards such as electric shock and fire.
- To avoid damage caused by a power surge or lightning strike, unplug the projector from the power outlet during thunderstorms or when it is not in use for a long time.
- Do not place any flammable objects near this projector so as to avoid fire.
- Do not block the lens with any object when the projector is turned on. Any object placed close to the lens may get very hot and/or deformed, and may even cause a fire.
- Do not block any of the vents of the projector, as this may cause a buildup of heat within the product and result in a fire.



Safety Precautions

- Do not place this projector on an unstable platform, stand, or table, so as to prevent it from falling and causing serious damage or personal injury.
- Do not look directly into the lens when the projector is turned on to avoid eye damage.
- Do not attempt to disassemble this projector as it may contain dangerous high voltage components. This projector must only be maintained and repaired by a qualified or authorized technician.
- Do not place this projector in an upright position, as it may fall over and cause injury or damage.
- Do not expose this projector to rain or moisture (operating humidity is 20% – 80%).
- Do not immerse this projector in, nor expose it to water or other liquids. Immediately unplug the projector if any liquid or object got into its housing, and have it checked by a qualified technician before using it again.
- Do not place this projector in any of the following environments:
 - In poorly ventilated or narrow spaces.
 - Near devices that produce a strong magnetic field.
 - In direct sunlight.
 - Close to a fire alarm.
 - In extremely hot, cold or humid environments.

What 's in the box

When opening the packaging, check the contents of the box against the list below. If there is anything missing, please contact the seller in due time.



Laser Projector



Voice Remote Control

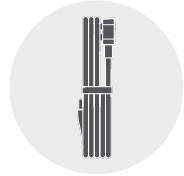

Power Cord



User Manual



Warranty Card

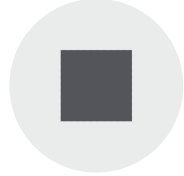

Cleaning Cloth

Note:

- The actual contents may vary depending on the country (or region) of sale, please refer to the actual product.
- Retain the original packaging for future storage or transportation.

What you need

Make the most of your projector

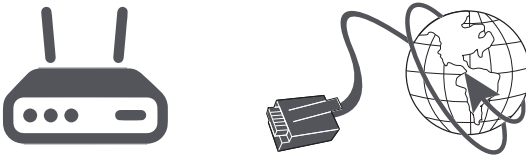

Router + Internet Connection
(needed for streaming)

Getting Started

Step 1: Set up

Remove your Projector from the box.
Be careful, it's heavy!

Desktop installation

Place your projector on furniture that can safely support it, ensuring the projector is not overhanging the edge of the supporting furniture.

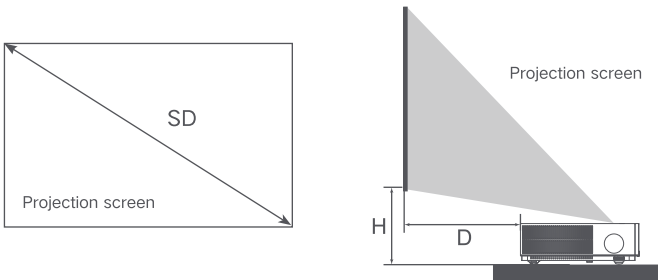

Determine the distance between the projector and the wall or screen according to the desired screen size.

Screen Dimensions (SD)	Relative Distance (D)	Relative Height (H)
80"	7.4 cm	31 cm
90"	11.6 cm	31.5 cm
100"	16.5 cm	34.5 cm
120"	25.5 cm	40.3 cm
150"	40 cm	48.5 cm

Screen Dimensions (SD):

The diagonal size of the projection screen (in inches).

Relative Distance (D):

The distance between the projector and the wall or screen (in cm).

Relative Height (H):

The distance from the bottom of the projector to the bottom edge of the projected image (in cm).

 Note:

The dimensions in the table above are for reference only, they are approximate and may slightly differ from the actual values.

Optional - Suspended ceiling installation (ceiling mount not included)

1. Install the mount.

Make sure the mount used to install the projector onto can support at least five times the weight of the projector. It requires a professional to carry out the installation.

2. When installing the projector onto a ceiling mount, make sure the screws meet the following specifications:

Screw Type: Non self-tapping screw M4 × 10
(diameter: 4 mm, length: 10 mm), 4 pcs.

For assembly dimensions, see the figure below.

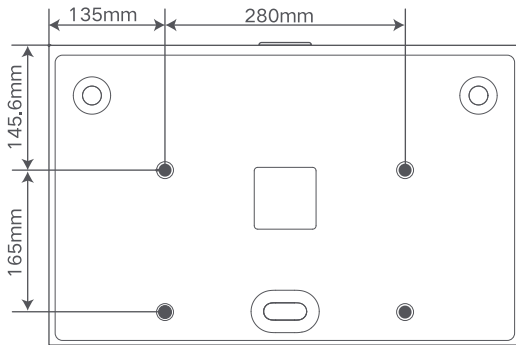

3. Adjust the mount depending on your needs and firmly fix the screws to complete the installation.

4. After turning on the projector, go to Settings - Projector - Projection Method to set the proper mode.

CAUTION:

- To avoid the convective heat transfer between the air inlets and air outlets, make sure there are no obstructions within 50 cm of the air inlets and heat dissipation vents.
- Keep the bottom of the projector 10 cm away from the ceiling when suspending it.
- Damage caused by incorrect installation will void the warranty.

Step 2: Power up

Connect your power cable to the projector, then plug it in to the wall outlet.

Power your projector remote by inserting the appropriate batteries. (batteries not included)

Connect other devices by referencing port label and descriptions on the next page.

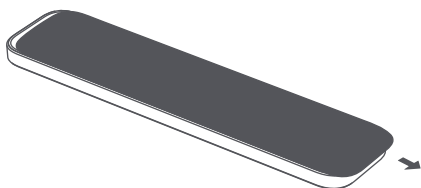

Step 1. Push the back cover in the direction of the arrow, and after hearing a sound, the back cover will separate from the remote control.

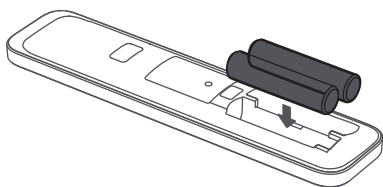

Step 2. Remove the back cover, then take out the battery.

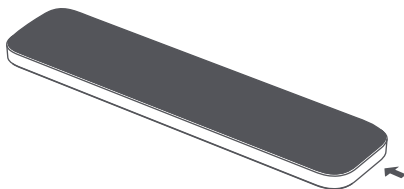

Step 3. Install the battery, then put the back cover onto the remote control and push it firmly in the direction of the arrow until it clicks into place. Once you hear a sound, it indicates that it has been installed properly.









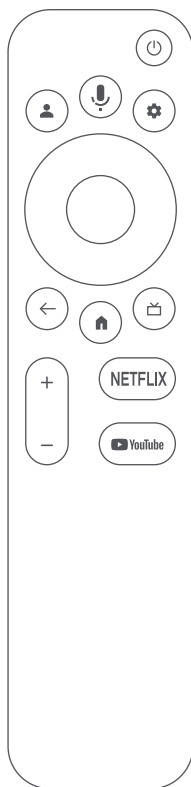



Note:

- Pay attention to the positive and negative poles when installing batteries in the remote control.
- When battery leaks, immediately wipe away any fluid with a dry cloth and replace the batteries with new ones.
- Dispose of used batteries according to local waste disposal rules and regulations of the country or area you live in.

Step 3: Grab your remote



-  **POWER:** Turn Projector on and off
-  **PROFILE SELECTOR :**
Switch between different Google Accounts
-  **SETTINGS:** Access the settings
-  **Google Assistant:**
Do more on your TV with your voice.
Press the Google Assistant button on your remote to get started.
-  **NAVIGATION PAD:**
Move up, down, left, or right, then press the middle button to confirm
-  **BACK:** Return to previous screen
-  **HOME:** Return to home screen
-  **Referring to the instructions below:**
 1. If Live Tab is supported in country then launch Live Tab.
 2. If device supports tuner then launch deep link to OEM app.
-  **Volume Button:**
 - + Increase the volume
 - Decrease the volume
-  **Netflix:** Access the Netflix App
-  **YouTube:** Access the YouTube App

Note:

- Follow the on-screen guide to pair the remote control with the projector. Hold the remote control close to the projector within a distance of 20 cm when pairing.
- It is recommended that the distance between the remote control and the projector is no more than 5 meters.
- The illustration of the remote control is for reference purposes only. Actual products and functions may vary due to the regions they are used in.

Step 4: Get to know your projector

Product Overview

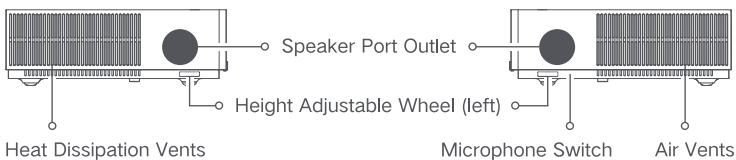
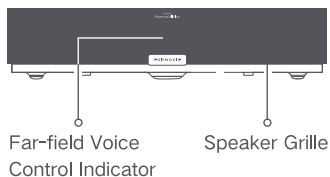
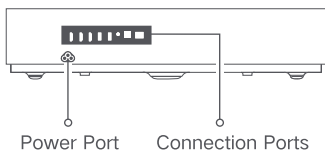
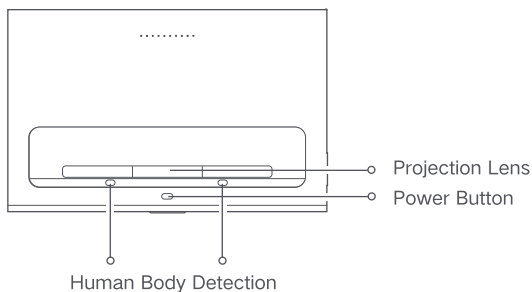

CAUTION:

- Do not place any flammable objects near the heat dissipation vent.
- Do not place any objects near the vents, as this may cause heat to build up inside the projector.
- Do not look directly into the lens so as to avoid eye damage as this projector emits strong light during use.

Connection Ports

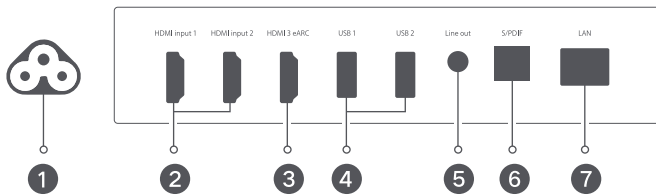

1 Power:

Connect your TV to the power source with the included power cable.

2 HDMI Ports:

Highest quality audio/video connection. Connect cable box, Blu-ray player, gaming console, or other devices to your projector using HDMI cables.

3 HDMI eARC Port :

Connect HDMI eARC/ARC (audio return channel) capable audio devices like sound bars or AV receivers.

4 USB Ports:

Connect a USB device to access photos, music and movies.

5 Audio Out Port:

Connect an analog cable to an external analog audio system.

6 Optical (Digital Audio Out):

Connect an optical cable to an external digital audio system.

7 Ethernet Port:

Connect an ethernet cable to your home internet router or switch.

Power Indicator

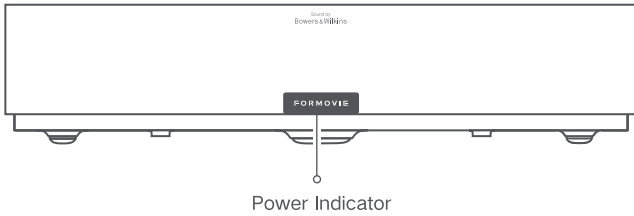

The power indicator (a soft white light) to the corresponding projector's status is as follows:

- After power on, the indicator stays on for a few seconds.
- The indicator remains on during startup and goes off after entering the system.
- The indicator remains on for a few minutes after turning off the screen.
- The indicator turns off after the projector is turned off.

Safety & Protection

The projector comes with an infrared sensor which is able to intelligently detect and protect the human eye from damage caused by strong light within the projected area.

The projector will reduce its brightness to the lowest possible value when the sensor is triggered and issue the following notification: "Do not look directly at the light source."

Human infrared sensor
& fresnel optical lens

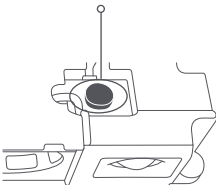

Front sensor range:
Approximately 55 °

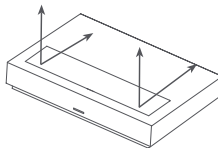

Left and right side sensor range:
Approximately 30 °

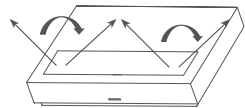

Step 5: Complete guided setup

Let's Connect

Follow the easy on-screen instructions to setup your projector.

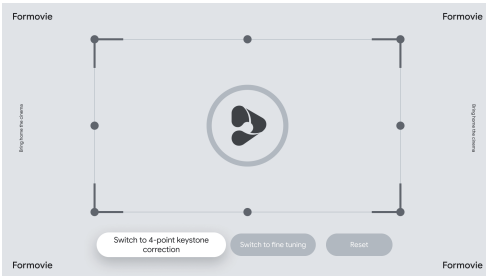
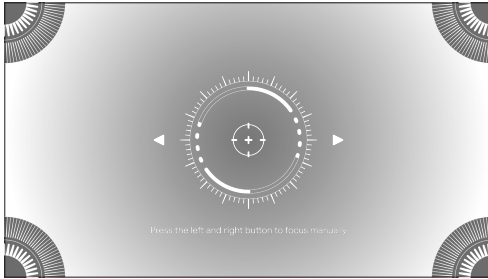

Interface may vary and is subject to change.

Once your language has been selected, you can quickly set up the projector using an Android™ phone with the pre-installed Google Home app.

And setup is done...Congratulations!

Continue using the remote to personalize your Home screen, streaming apps line-up, stream movies, and so much more.

For more detailed instructions, go check the electronic User Manual in Launch Board.

Key things to know:

A paid subscription or other payments may be required for some streaming apps. Streaming apps availability are subject to change and vary by country.

Care & Maintenance

Heat Dissipation Maintenance

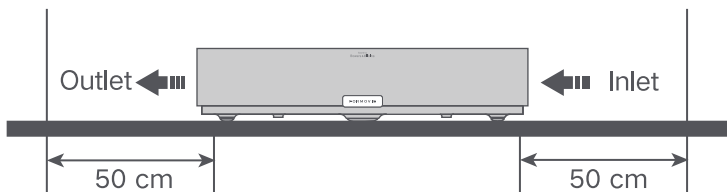



Note: Do not touch the heat dissipation vent or ventilation vents as temperatures can reach up to 65 ° C.

 Note:

Do not place any objects within 50 cm of the projector's air vents, as this will affect its heat dissipation effect.

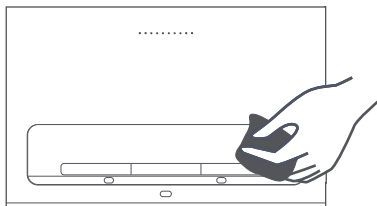
Cleaning & Maintenance



Only use the cleaning cloth that comes with the projector or a professional grade cleaning cloth to clean the projector's glass.

Do not use any abrasive cleaning products, solvents, chemicals, or other rough objects so as to avoid scratches or corrosion.

Turn off and unplug the projector before cleaning.

 Note:

- The projector is not water resistant. Do not allow liquids to penetrate the projector, especially areas such as the power indicator, glass cover, air vents, connection ports, and speaker grilles.
- Only use the cleaning cloth that comes with the projector or a professional grade cleaning cloth to clean the projector's lens.

Troubleshooting

Fault	Solution
No projected image	Turn off the projector and disconnect from the power, then plug in the power cord and turn on the projector.
System crash	Turn off the projector and disconnect from the power, then plug in the power cord and turn on the projector.
Screen display error	Turn off the projector and disconnect from the power, then plug in the power cord and turn on the projector.
Remote control is missing or not paired and the projector cannot be turned on remotely.	Turn off the projector and disconnect from the power. Wait for five minutes, then plug in the power cord and turn on the projector. After the projector has been restarted, pair the remote control again.
If the projector overheats, it will automatically turn off.	Please remove any obstacles from the air inlets and outlets so as to ensure a smooth airflow through the projector. Follow the instructions above to restart the projector.
Other Internal System Errors	Please contact a qualified technician to service the device, or return the projector to the after-sales department.

Product Certifications



Dolby, Dolby Vision, Dolby Atmos, and the double-D symbol are registered trademarks of Dolby Laboratories Licensing Corporation. Manufactured under license from Dolby Laboratories. Confidential unpublished works. Copyright © 2012–2024 Dolby Laboratories. All rights reserved.



The terms HDMI, HDMI High-Definition Multimedia Interface, HDMI Trade dress and the HDMI Logos are trademarks or registered trademarks of HDMI Licensing Administrator, Inc.



For DTS patents, see <http://patents.dts.com>. Manufactured under license from DTS, Inc. (for companies headquartered in the U.S./Japan/Taiwan) or under license from DTS Licensing Limited (for all other companies). DTS, DTS:X, and the DTS:X logo are registered trademarks or trademarks of DTS, Inc. in the United States and other countries. © 2022 DTS, Inc. ALL RIGHTS RESERVED.



Sound by
Bowers & Wilkins



Google TV is the name of this device's software experience and a trademark of Google LLC. Google, YouTube, Android, Google Home, and other marks are trademarks of Google LLC.

The product marking and safety information are located at the bottom of the product.

Manufacturer:

Formovie (Chongqing) Innovative Technology Co., Ltd.

Address:

4-401, # 2 Longgang Road, Guojiatuo Area, Jiangbei District, Chongqing, China

www.formovie.com



D66050000331

D