

Quick Start Guide

# Rvolution

## PlayerOne

English

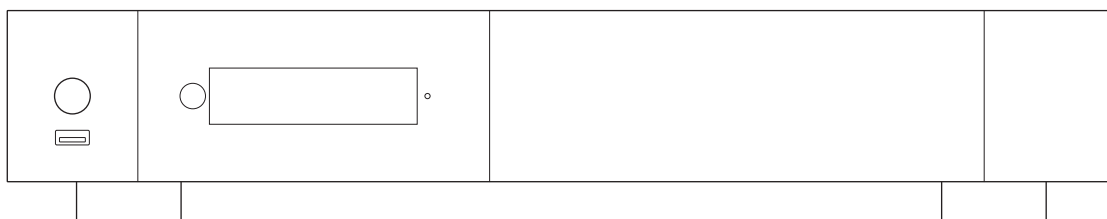



## Important Safety Instructions

- 1) Read and keep these instructions.
- 2) Heed all warnings.
- 3) Follow all instructions.
- 4) Do not use this apparatus near water.
- 5) Clean only with dry cloth.
- 6) Do not block any ventilation openings.
- 7) Do not install near any heat sources such as radiators, heat registers, stoves, or other apparatus (including amplifiers) that produce heat.

## WARNING:

TO REDUCE THE RISK OF FIRE OR ELECTRIC SHOCK, DO NOT EXPOSE THIS APPLIANCE TO RAIN OR MOISTURE. DANGEROUS HIGH VOLTAGES ARE PRESENT INSIDE THE ENCLOSURE. DO NOT OPEN THE CABINET. REFER SERVICING TO QUALIFIED PERSONNEL ONLY.

THE APPARATUS SHALL NOT BE EXPOSED TO DRIPPING OR SPLASHING AND THAT NO OBJECTS FILLED WITH LIQUIDS, SUCH AS VASES SHALL BE PLACED ON THE APPARATUS.

## CAUTION:

DANGER OF EXPLOSION IF BATTERY IS INCORRECTLY REPLACED. REPLACE ONLY WITH THE SAME OR EQUIVALENT TYPE. DO NOT OPEN COVERS AND DO NOT REPAIR YOURSELF. REFER SERVICING TO QUALIFIED PERSONNEL.



This product complies with European Low Voltage (2006/95/CE), Electromagnetic Compatibility (2004/108/EC) and Environmentally-friendly design of Energy-related Products (2009/125/EC) Directives when used and installed according to this instruction manual.

## Getting More Information

Due to the regular evolution and the addition of new functionalities, provided by firmware and software updates, it is impossible to cover all functionalities in this user's guide. For this reason, we invite you to visit our online **Rvolution Knowledge Base**. You will find a large amount of tutorials and various help topics concerning the use of the media player and Rvolution applications:

[rvolution.uservoice.com/knowledgebase](http://rvolution.uservoice.com/knowledgebase)

## About Rvolution

Rvolution designs and manufactures only professional grade Video Management Systems; delivering the highest quality, outstanding performance, and best possible user experience.

All our products are designed to provide our end-user customers with convenient and intuitive access to their entire movie library collection, in stunning 4K, High Definition resolution. Rvolution devices are made to improve the movie watching experience, in residential and commercial environments.

To ensure the ultimate performance, all Rvolution devices are supplied to authorized resellers through a worldwide network of established and well respected partners.

More info: [rvolution.com](http://rvolution.com)



### WEEE symbol

Correct Disposal of This Product. (Waste Electrical & Electronic Equipment) Applicable in the European Union and other European countries with separate collection systems.

This marking on the product, accessories or literature indicates that the product and its electronic accessories (e.g. remote handset) should not be disposed of with other household waste at the end of their working life. To prevent possible harm to the environment or human health from uncontrolled waste disposal, please separate these items from other types of household waste and recycle them responsibly to promote the sustainable reuse of material resources.

More info can be found here:

<http://ec.europa.eu>



Manufactured under license from Dolby Laboratories.  
Dolby and the double-D symbol are trademarks of Dolby Laboratories.



DTS, the Symbol, & DTS and the Symbol together are registered trademarks & DTS 2.0+Digital Out is a trademark of DTS, Inc. Product includes software. © DTS, Inc. All Rights Reserved.

## Table of Contents

### English Quick Start Guide

---

- 4 • General, Key Features
- 5 • Organize your Video Collection with Movie Covers
- 6 • Package Contents, HDMI Cable, IR Extender
- 7 • Exterior (Front view, Rear view), Programming buttons to control TV or other device
- 8 • Remote Control, Third Party Control
- 9 • Connecting Your Media Player to Your TV Without AV Receiver
- 9 • Connecting Your Media Player to Your TV Through AV Receiver
- 10 • Audio Coaxial and Optical
- 11 • Getting Started, Audio and Video Settings
- 12 • Connecting USB Drives, Using Internal Drive, SD / MMC Cards
- 13 • Ethernet, Wi-Fi, Bluetooth, Ethernet filter
- 14 • R\_video, Explorer
- 14 • How to create an account R\_volution
- 15 • Accessing Network Drives And Access To The Player
- 15 • How To Transfer Your Files Using Explorer
- 15 • Slideshow Function, Video Properties, Video And Audio Playback Options
- 15 • How To Install A New App, How To Add a Favorite
- 16 • How to Create a Movie Collection in R\_video
- 17 • R\_video, Wrong Storage ID Error
- 17 • How to Identify a Movie / Episode, How to Delete a Movie / Episode
- 18 • How to Identify Unidentified Movies & TV Shows
- 18 • 3D, 4K and UHD Files
- 18 • How to Change a Picture
- 18 • Multiple hard drives
- 19 • Parental Control, Personal Categories, R\_video On Start-Up, Filter and Sort
- 19 • Search Engine
- 19 • Filter and Sort
- 19 • Sagas / Groups, Widescreen 2.35:1 Mode
- 20 • Subtitle Display Options
- 20 • Resume Video Playback
- 20 • Direct Access During Video Playback, Show Special Top Banner, Zoom And Aspect Ratio Settings
- 20 • Media Info, Generate a CSV File from a R\_volution Collection, Add a Category, Token Error Message
- 21 • Firmware Upgrade
- 21 • Factory Reset
- 21 • Hardware Reset

## General

The Revolution Player is a universal media player compatible with HDR10, HDR10+, Dolby Vision that offers Dual HDMI output, internal HDD rack enclosure and 3D capabilities.

## Key Features

- **Processor:** Realtek RTD1619DR
- **Memory:** 4GB RAM, 32GB flash
- **HDR:** Display your HDR, HDR10+ and Dolby Vision video content on a compatible display.
- **Video Processing:** Dolby Vision VS10 video processing for the best picture possible.
- **Dual HDMI:** Use the second HDMI to separate audio and video for the best performances.
- **4K 50/60p:** Display your 4K video content in 3840x2160p at 50 Hz or 60 Hz (HDMI 2.0a).
- **MKV Player:** Playback SD, HD and UHD video contents in MKV, M2TS, DVD / BD / UHD ISO and other modern video file containers and formats, including top quality HEVC/H.265 video codec, with very high bit-rates up to 400 Mbp/s.
- **HDD Rack Option with Hot Swap Function:** Easily and quickly insert and exchange internal 3.5" SATA hard drives.
- **Network Player:** Connect your media player on your local network and enjoy your content from a computer PC/MAC or a NAS via SMB.
- **USB Ports:** Conveniently connect hard drives, USB flash drives, USB card readers, computer mouse / keyboard, and other USB storage devices.
- **USB Port 3.1 and Type-C:** Read or copy your files in ultra high speed.
- **Full Range of A/V Connectors:** S/PDIF coaxial and optical audio output, audio analog RCA, RCVBS, HDMI 2.0 CEC, HDMI Audio only, HDMI Input.
- **Multichannel home cinema audio:** Bitstream (RAW), downmix LPCM stereo.
- **Video Output Flexibility:** Output video in any resolution and format including SD, 1080p (1920x1080), Ultra HD (3840x2160p) and true 4K (4096x2160p) up to 12-bit by primary color.
- **Auto Framerate:** Auto framerate detection 24/50/60p (compatible 24.000 Hz / 23.976 Hz).
- **Playback Memory:** Resume playback from the last position.
- **Advanced File Browser:** Convenient file browser with powerful file management (select, select all, copy, cut, past, delete, rename, ...).
- **Backlit Remote Control:** High quality remote control with direct access and shortcuts with backlit buttons and recordable buttons to control another device.
- **WiFi ac 2T2R with 2 removable antennas:** Playback and transfer your video content wirelessly with high bitrate.
- **Widevine L1 DRM:** Watch premium online video services in HD and UHD.
- **SACD (DSD):** Play top quality Super Audio CD (DSD) music files in all any popular formats (ISO, DFF, DSF), including both stereo and multichannel files as well as files which use DST compression.

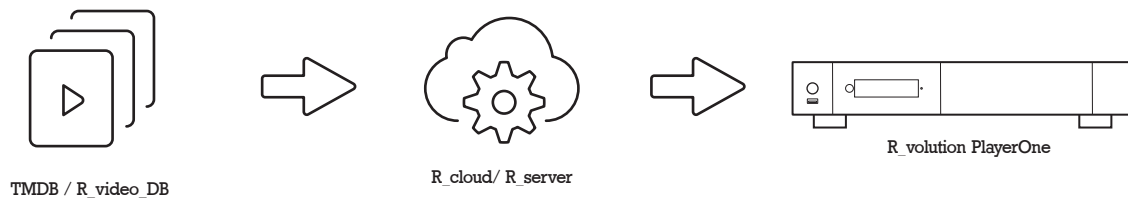

## Organize Your Video Collection With Movie Covers

- **R\_video Interface:** Browse your movie and TV show collection with cover art and media information: (subtitles, actors, director, release date...). R\_video features an automatic category index of movies and TV shows directly to the player, without requiring a computer.
- **R\_search:** Easy access to your movies or TV shows, thanks to R\_video powerful search engine combined with smart filters (actor, director, length, rating, release date...).
- **R\_video Stand-Alone:** Add, edit or delete movie covers directly on your R\_revolution player using the remote control (no PC required). Change the posters, edit the synopsis, change the associate category, create and organize your own personal categories, etc.
- **R\_video on Start-up:** Enable/disable start-up for R\_video from system boot in the settings.
- **R\_video Collections:** Create and manage one collection by each family member or one collection by HDD and switch easily from one collection to another.
- **Parental Control:** With the parental control feature, you can designate movies as "children's" and block access to other movies with a PIN code. Thus, your children can safely access only their movies! In addition, the child mode provides direct access to movies for greater ease of use.
- **Movie Sagas:** The saga films are automatically placed in groups and sorted by release date. A saga cover dedicated to the collection is associated with the group and movies are displayed in a stunning carousel with great 3D motion effects!
- **Automatic Seen Status:** Your films and episodes are automatically marked as "Seen" or "Ongoing" status. And when you finish playing a TV episode, R\_video automatically offers to launch the next episode!
- **R\_video Next:** Direct access to the current or next episode / film from saga directly from the R\_video home page.
- **R\_video Soundtracks:** With the amazing R\_video Soundtracks, you can explore your collection, while listening to the soundtrack associated with your movies, TV shows and sagas.
- **R\_video Widescreen:** Set the user interface in 2.35:1 aspect ratio.
- **R\_video Off-line:** Save a collection locally and use it without any Internet connection.
- **R\_video Trailers:** Watch the trailer of your movies.
- **R\_sub:** Easily download the subtitle of a movie or TV show episode, directly from the player.
- **R\_sync:** Thanks to R\_sync, your movie collections are automatically synchronized to your other R\_revolution players.
- **R\_revolution Explorer:** Explorer is the easiest way to launch the playback of most of multimedia files such as UHD, BD and DVD ISO, BDMV, M2TS, MKV, MP4, MOV, MP3, FLAC, JPG... R\_revolution Explorer makes file exploration so easy!

# Package Contents

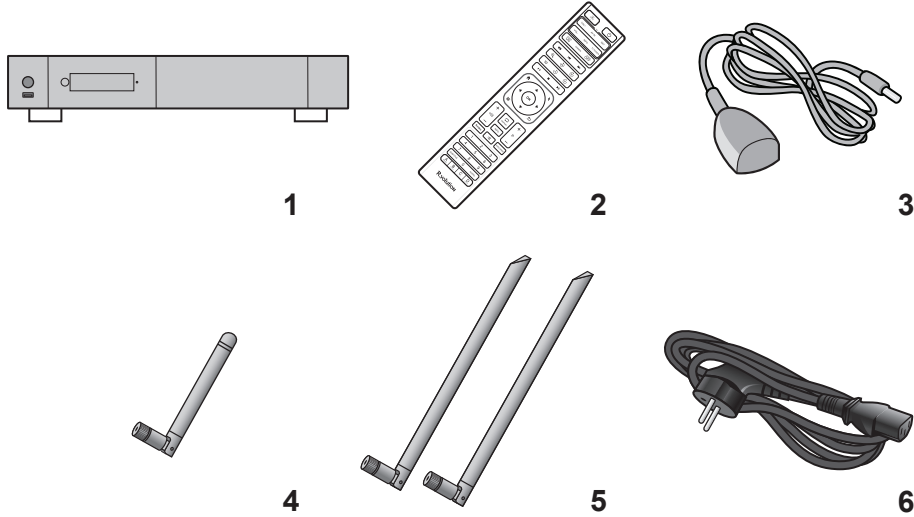

- 1. R\_volution PlayerOne
- 2. IR Remote Control
- 3. IR Extender
- 4. RF Antenna
- 5. Wi-Fi Antennas
- 6. Power Cables

**NOTE:** Additional items (optional) may be included into the package, depending on player configuration, region, and distributor.

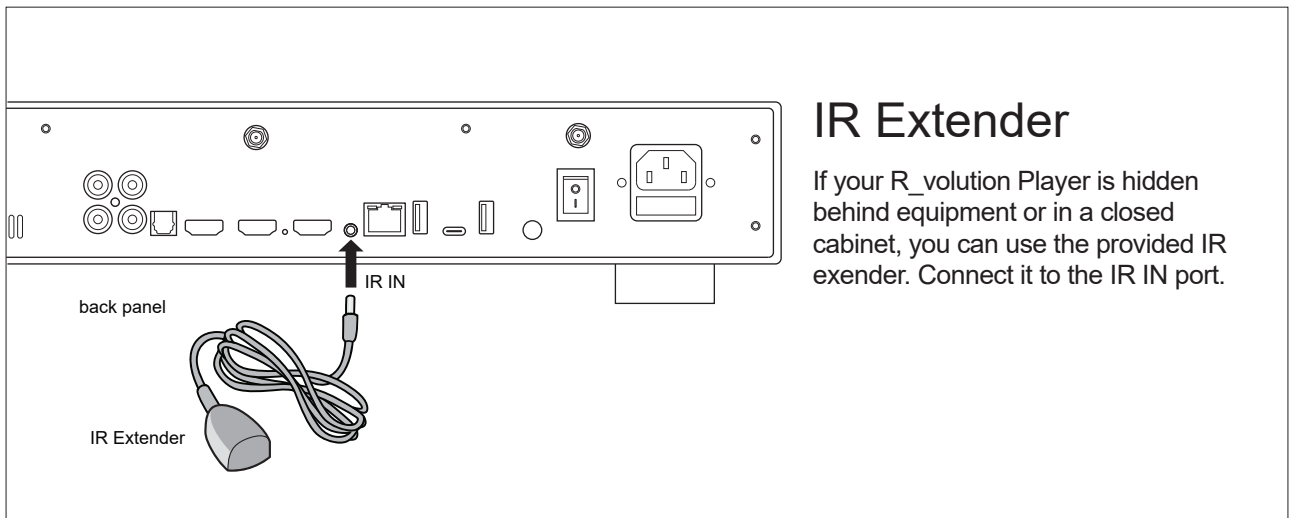

## Front View

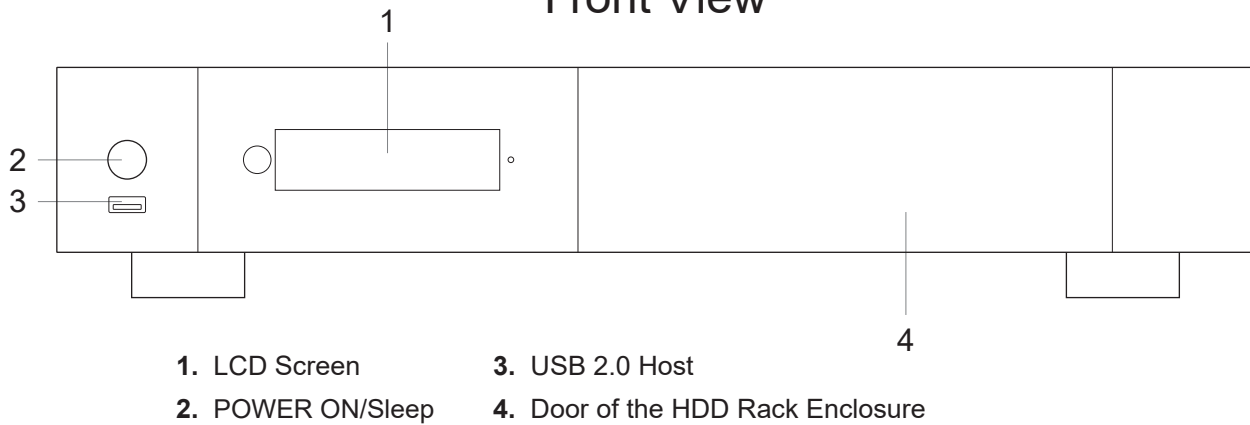

## Rear View

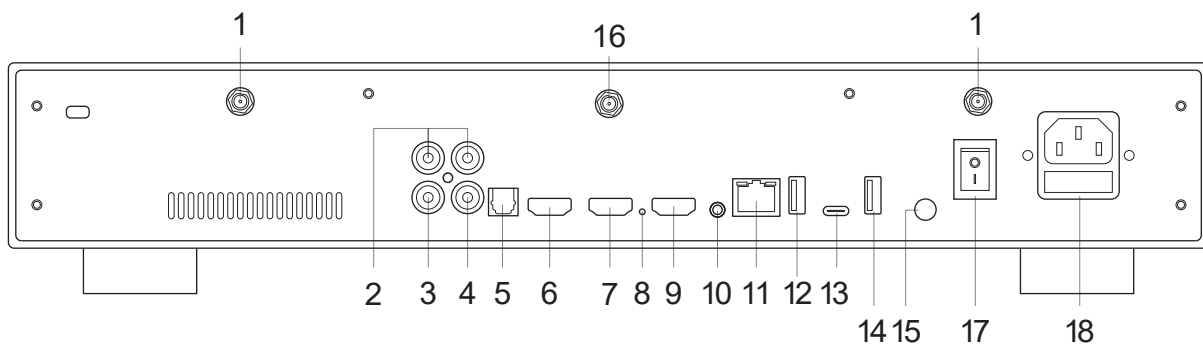

- |                                     |                                  |
|-------------------------------------|----------------------------------|
| 1. Wi-Fi Antenna                    | 10. IR IN (IR extender included) |
| 2. Analog Audio Output Right / Left | 11. LAN 10/100/1000              |
| 3. Analog Video Output CVBS         | 12. USB 2.0 Host                 |
| 4. Coaxial Digital Audio Output     | 13. USB TYPE-C                   |
| 5. Optical Digital Audio Output     | 14. USB 3.1 Host                 |
| 6. Audio HDMI Output (Audio only)   | 15. Ground                       |
| 7. Main HDMI Output (Video + Audio) | 16. RF Antenna                   |
| 8. Restore                          | 17. Power ON/OFF                 |
| 9. HDMI Input                       | 18. Power Input                  |



# Remote Control

1. **LIGHT:** Turn on the backlight of the remote control.
2. **POWER:** Toggle power ON/OFF.
3. **TV SECTION:** Programmable buttons to control TV or other external device; *For more info, please refer to the previous page.*
- 4-5. **POWER ON/OFF:** Discrete power ON/OFF.
6. **DIMMER:** Toggle front OLED screen ON/OFF (future option).
7. **DELETE:** Delete the previous character entered.
- 8-9. **PREV/NEXT:** Go to the previous/next chapter.
10. **ZOOM:** Zoom In / Out (overscan).
- 11-12. **-60/+60:** Timeline navigation (-/+ 60 sec.).
- 13-14. **-10/+10:** Timeline navigation (-/+ 10 sec.).
15. **3D:** Open the 3D settings.
16. **< >:** Switch the Audio Mode.
17. **STOP:** Stop video playback.
18. **PLAY/PAUSE:** Start / Pause playback.
- 19-20. **UP:** Next file (Explorer). **DOWN:** Previous file Explorer).
- 21-22. **LEFT/RIGHT:** Timeline navigation (-/+1 min).
23. **HOME:** Go to Main Menu (Home Page).
24. **MOUSE:** Switch to the virtual mouse mode.
25. **MENU:** Show / Hide the pop-up menu.
26. **BACK:** Return or Stop playback.
- 19-22. **ARROWS:** Navigate menu selection.
27. **OK:** Enter or validate the current item.
- 28-29. **VOLUME +/-:** Increase / Decrease volume.
30. **REPEAT:** Repeat playback (file, all, off).
31. **INFO:** Show / Hide the pop-up info (properties).
- 32-33. **PAGE +/-:** Timeline navigation (+/-10 sec).
34. **R\_VIDEO:** R\_video shortcut.
35. **MUTE:** Mute audio.
36. **EXPLORER:** R\_olution Explorer shortcut.
37. **NUMBER Buttons:**
  - 1-9: direct access to 10-90% (video playback or movie list).
  - 0: Restart from the beginning (video playback or movie list).
38. **SUBTITLE:** Subtitle switch.
39. **AUDIO:** Audio track switch.
40. **RED (A):** Contextual shortcut.
41. **GREEN (B):** Contextual shortcut.
42. **YELLOW (C):** Contextual shortcut.
43. **BLUE (D):** Contextual shortcut.

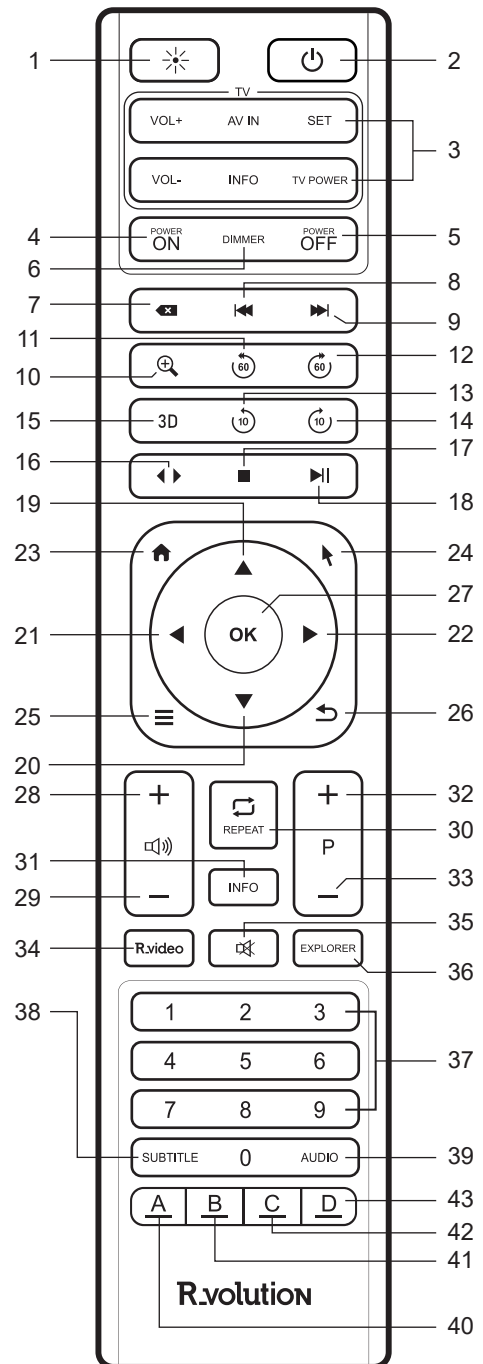

## Using the Remote Control

Within about 26 ft (8m)

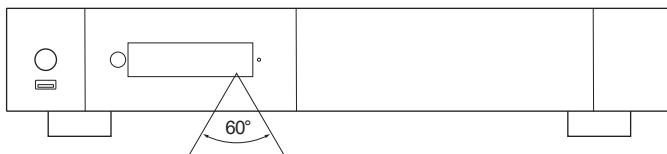

When using the remote control, the front window of the remote control should be pointed to the infrared sensor on the front panel within an angle of  $\pm 60^\circ$  and a range of about 26 ft.

*Please use alkaline batteries.  
Please observe polarity when inserting batteries.*

## Third Party Control

You can control your R\_olution player using third party devices such as Control4, Crestron, RTI, ProControl, Savant, Logitech, Elan...

**More info:**  
[r.olution.uservice.com/knowledgebase](http://r.olution.uservice.com/knowledgebase)

## Connecting Your Player to Your TV Without AV Receiver

If you do not own an AV Receiver or sound bar, the most convenient and easy way is to connect your player directly to your TV. To do it, connect the main HDMI output of your media player to a free HDMI input of your TV or your front projector. If you have projector, please use an AV receiver (next procedure) or an audio analog amplifier and connect it to the player Analog Outputs using RCA connectors.

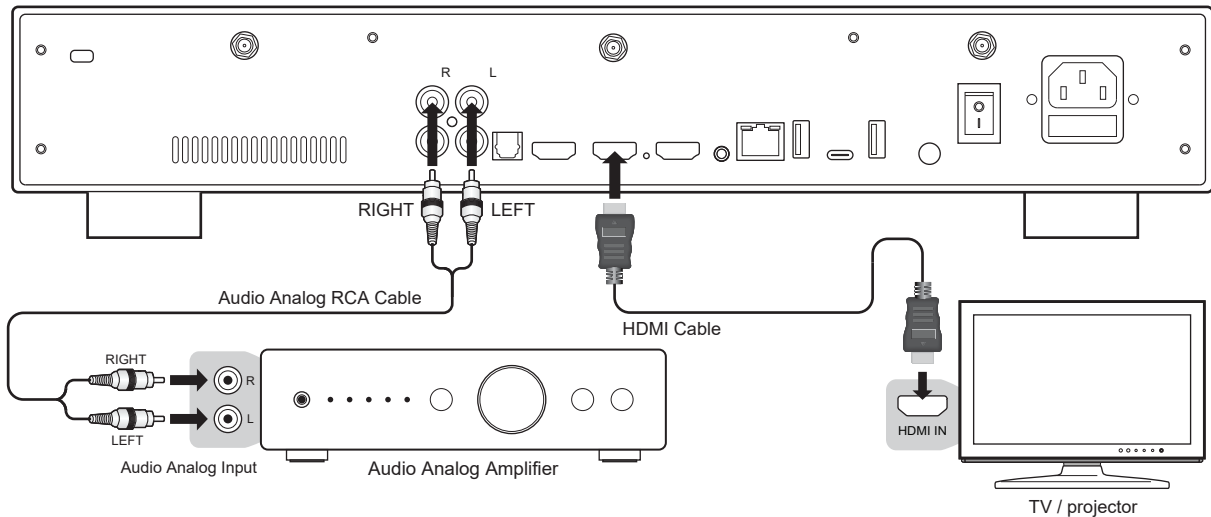

**⚠️ If you get a BLUE SCREEN, it is because you are using HDMI Audio Only instead of HDMI Main for the TV.**

## Connecting Your Player to Your TV Trough AV Receiver

If you own an AV Receiver, the most convenient and easy way is to connect your Player to your TV through your AV receiver or soundbar. To do it, connect the main HDMI output of your Player to a free HDMI input of your AV receiver, then connect the HDMI output of your AV receiver to your TV or your front projector. If your TV is compatible with 4K HDR, your AV receiver also has to be compatible with the 4K HDR format. If not please use the HDMI Audio Only Output as explained on the next page.

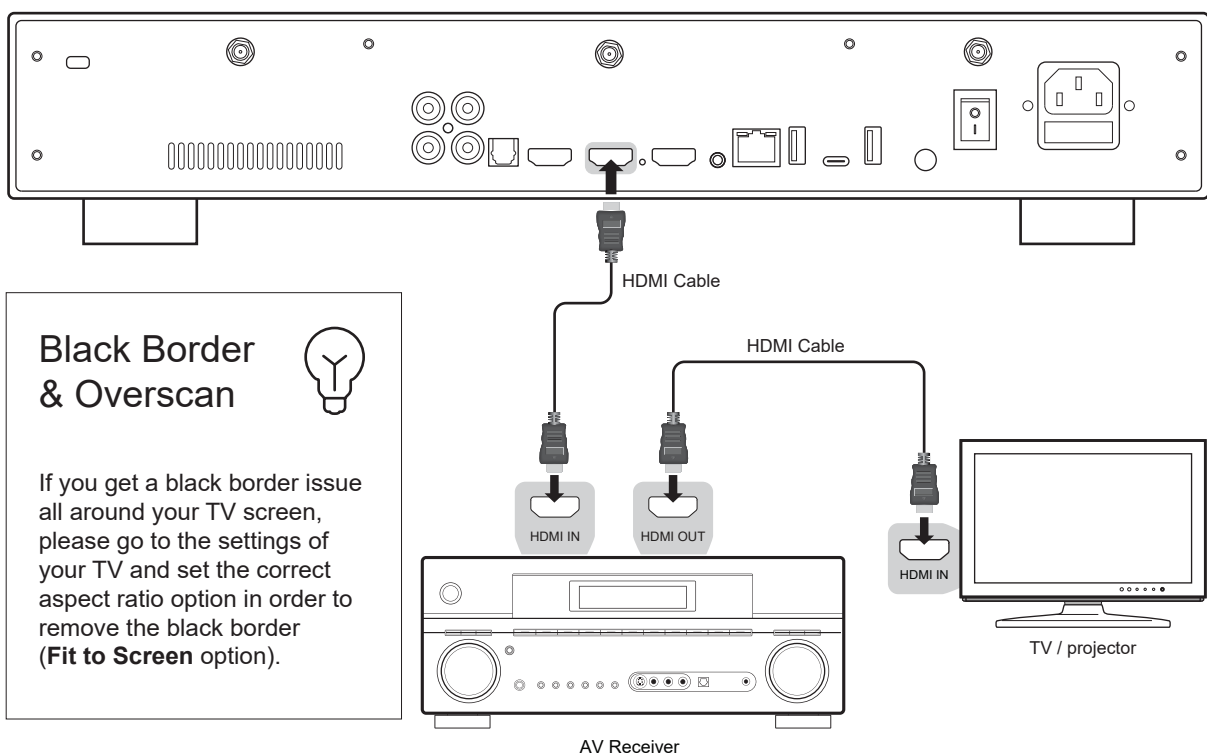

If your AV receiver is not compatible with 4K HDR, please use the HDMI Audio Only output as following:

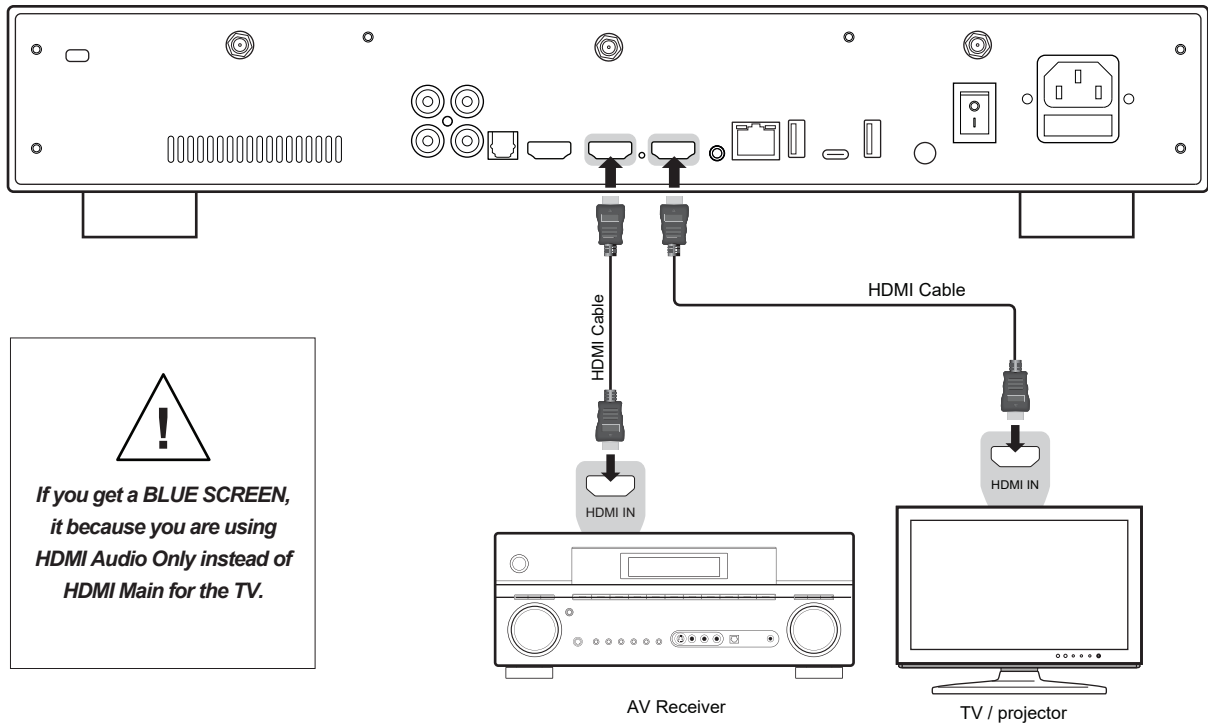

## Audio Coaxial and Optical

If your AV receiver is not compatible with HDMI, you can connect your player to your AV receiver using SPDIF optical (Toslink) or coaxial outputs as following:

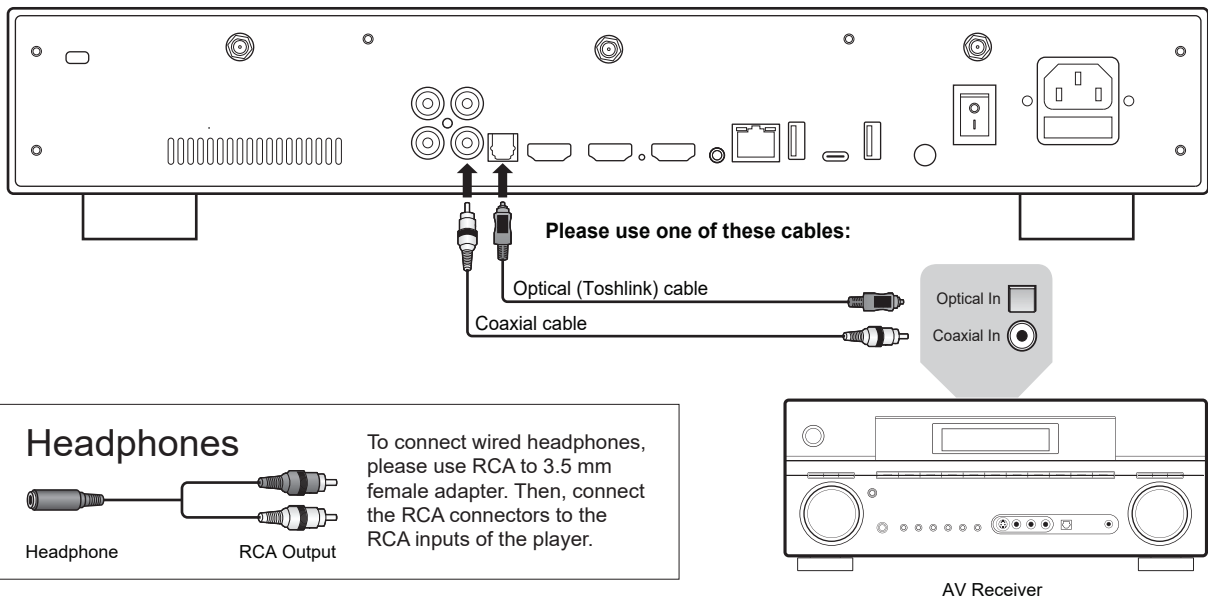

## Ethernet

The media player provides two network connection methods: through Ethernet cable or through the built-in wireless LAN adapter. For the fastest and most stable network connection, we recommend using an Ethernet cable whenever possible. Plug one end of a network cable (straight Ethernet cable) into the **LAN port** on the back of the media player (Category 5E or more). Then, plug the other end of the network cable into a LAN port on the broadband router or modem (or switch if you are using one).

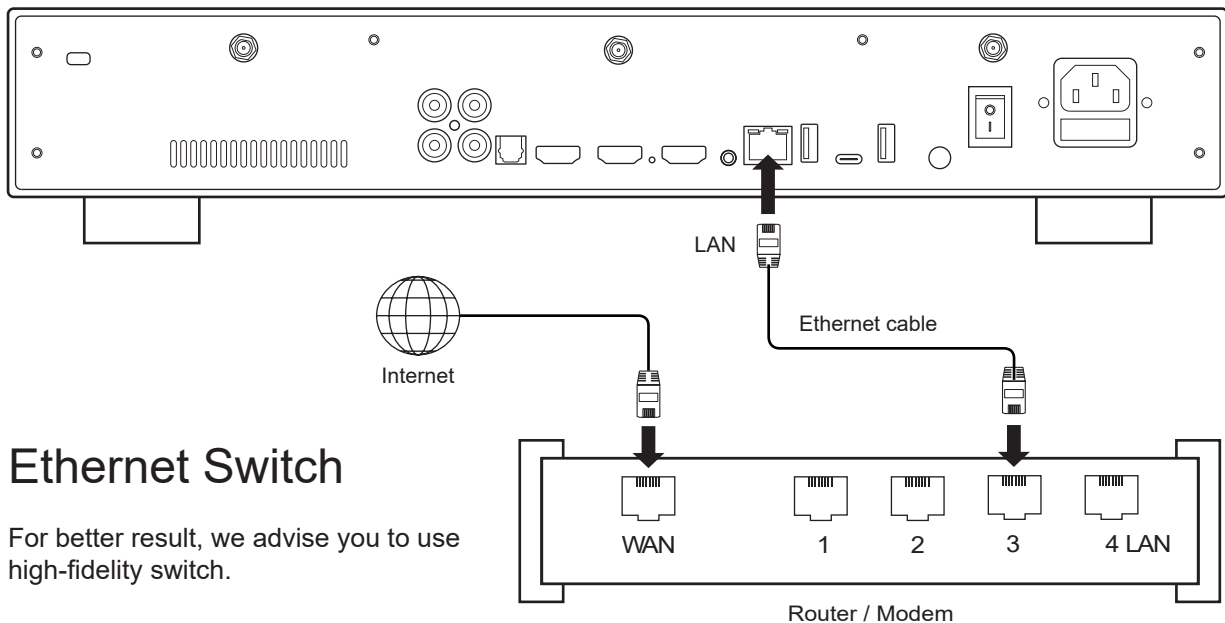

## Ethernet Switch

For better result, we advise you to use high-fidelity switch.

## Wi-Fi

To set the wireless feature, start to connect the antennas to the Wi-Fi connectors located on the back of the media player. Then, turn on your media player and go to: Setup > Network > Wireless connection (Wi-Fi). Then click on Edit settings. You will be able to select a wireless network and enter the security password.

## Ground

The ground connector on a player, often referred to as a grounding terminal, is used to establish a connection between the player and an external grounding system. It serves to dissipate any static electricity or electrical interference that may accumulate on the device, helping to maintain optimal audio and video performance. Obtain a grounding cable, which is typically a wire with a ring terminal at one end. Ensure the cable is of sufficient length to reach the grounding point or system you plan to connect it to. This could be a dedicated grounding terminal, a grounding rod, or another component in your audio/video setup that has a grounding provision.

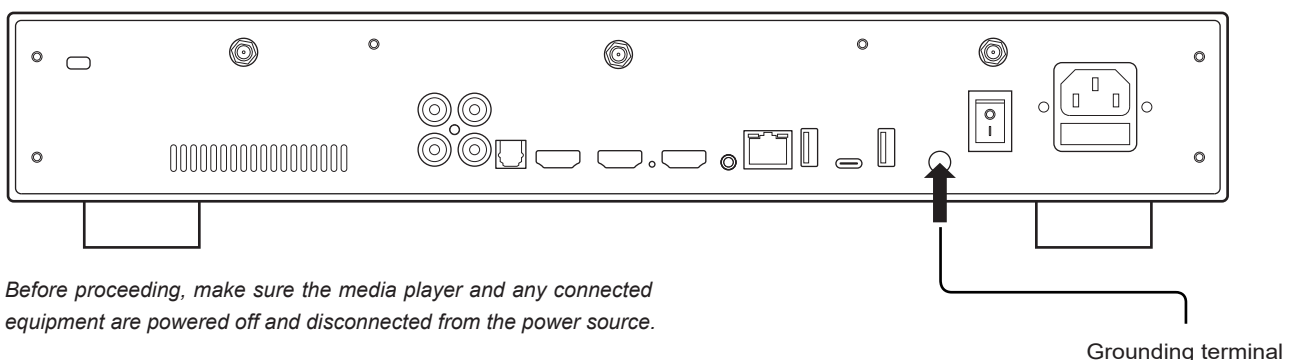

*Before proceeding, make sure the media player and any connected equipment are powered off and disconnected from the power source.*

If you have a R\_volution NAS or any other NAS, please connect the components as follows:

### R\_volution PlayerOne

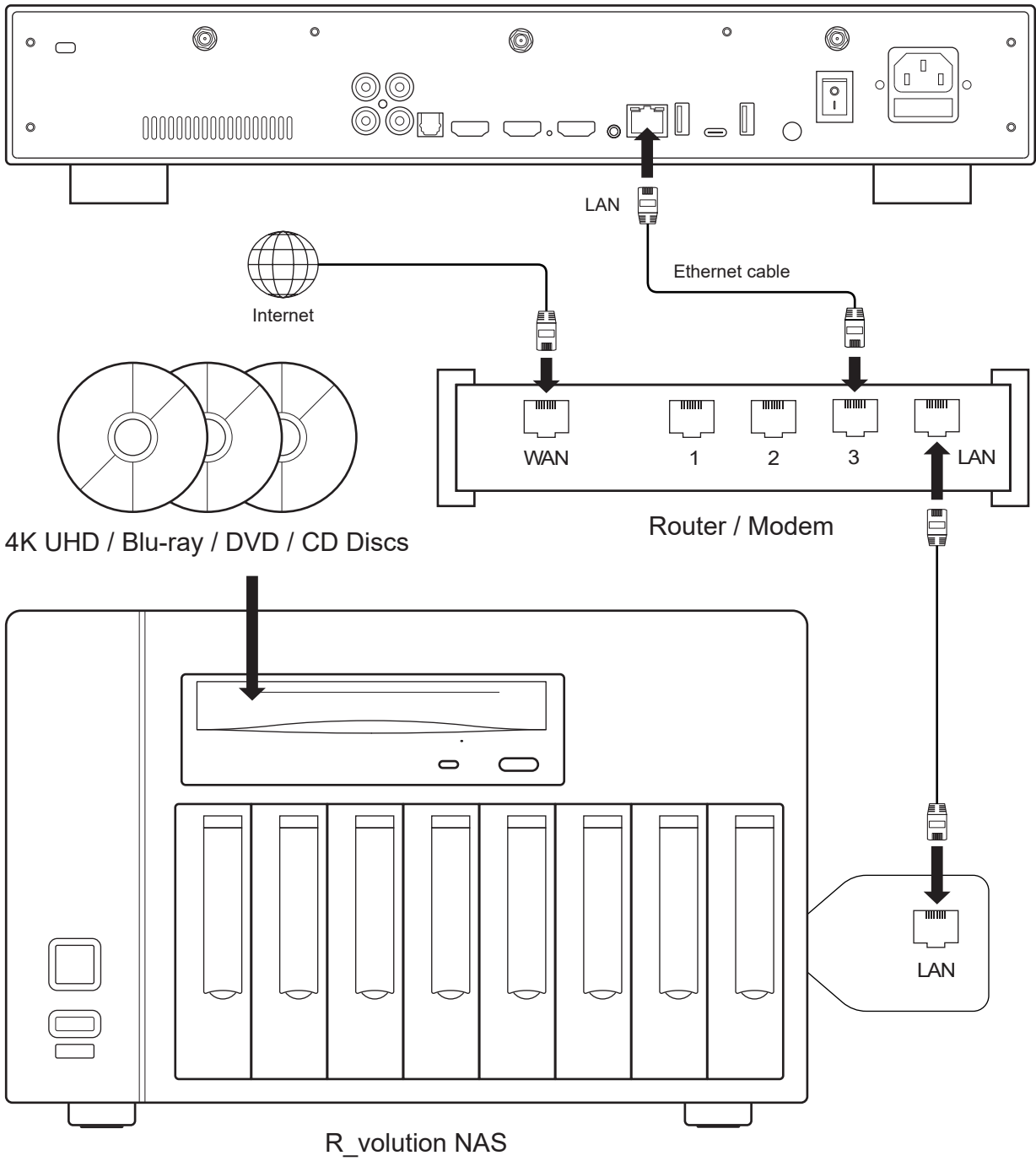

## Getting Started

- ⚠ **Make sure to use the HDMI OUT (main) and not HDMI IN output to connect your player to your TV or video projector.** Plug in and turn on the player. The player will go through its initial start-up procedure (takes less than one minute).
- ⚠ **If you experience a black screen or no video signal, please consult the following knowledge base:** [revolution.uservice.com/knowledgebase](http://revolution.uservice.com/knowledgebase)

You will then be taken to a quick setup screen. Follow the steps to set the language, resolution, and network access.

Finally, you should see the main screen with access to the Video (Media Center), and Explorer applications, among others, as well as **Settings** and **Android Apps**.

To set the default language for audio tracks and subtitles for video content playback, go to **Settings > Playback** and choose your preferred default language for audio tracks and subtitles.

## Audio settings

The **Audio** section of the **Settings** menu allows you to set preferences for audio output formats. If you are using an HDMI compatible multi-channel AV receiver, please set the **Digital Audio Connector** option to **HDMI (HD Audio On)**. If your home theater amp / preamp is not HDMI compatible, set the **Digital Audio Connector** option to **S/PDIF (HD audio off)**.

We recommend that you set the **Digital audio output mode option** to **Auto**. But it may be a good idea to select **PCM** mode (with decoding) for certain types of audio formats like AAC if your AV receiver cannot decode this format. **Bitstream** mode always sends the audio stream to your AV receiver in an undecoded way. But in this mode, some audio formats may not work if your AV receiver does not support these formats.

In order to listen to music in lossless or uncompressed format, you can set the **Maximum digital output sample rate** option to **192kHz**. However, please be careful because this mode can generate crackling in the speakers if you use an incompatible 192kHz amplifier or soundbar, or if you do not use an amplifier or soundbar at all (sound from the TV). In this case, select the **Auto** option.

## Video settings

By default, the player automatically adjusts the video output according to the resolution of your television. It is strongly recommended to leave the resolution settings in **Auto** mode (in **Settings > Video**). If your TV or projector is compatible, we recommend the **Y'CbCr 4:4:4 / 10-bit** or **12-bit** mode for the best video performance. **Warning!** *The higher you move up in the video output specifications, the higher the bit rate will be and will require a quality cable.*

### **HDR > SDR Conversion**

*To benefit from the best SDR performance on HDR content, we invite you to go to **Settings > Video > HDR and Dolby Vision Settings** and select the **Dolby VS10 engine for HDR, DV video** option. In some cases, the picture could be washed out. In this case, go to **Settings > System > Video > HDMI Range Mode > Full Range**. If you do not apply this setting.*

## External Drives

If you are using an external HDD 2.5", please use the USB cable provided with your HDD for best performance.

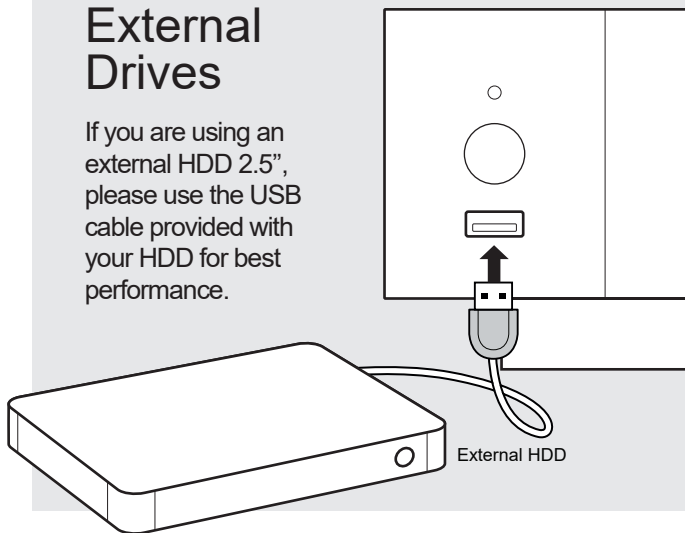

## Connecting USB Drives

You can connect your USB drives to one of the available USB ports. If you want to play video files, USB 2.0 is enough to support very high bitrate (up to 480 Mbps) and more reliable than USB 3.0. If you want to transfer files, you can use the USB 3.1 or USB Type-C ports.

**Note:** A dedicated USB icon located on the home page can help you detect if the drive is properly connected.

Power provided by USB ports may not be enough to allow the USB drive to function correctly; depending on the drive. Please do not disconnect or switch off the USB drive during write (copy / transfer) operations.

The player is compatible with **UASP HDD docking stations** as well as **USB hubs**.

## Using Internal Drive

To insert the internal 3.5" SATA HDD, please open the rack door, then insert the drive into the internal enclosure until 3/4, then complete the installation by closing the door. This operation will complete the installation of the disk into the rack. The media player is compatible with drives formatted in FAT16/FAT32 (read-write), EXT2/EXT3/EXT4 (read-write), NTFS (read-write), exFAT (read-write), HFS/HFS+ (Mac OS Standard/Extended) (read-only), BTRFS (read-write). It is possible to format your hard drive via Explorer via Menu / Format.

More info: [revolution.userservice.com/knowledgebase](http://revolution.userservice.com/knowledgebase)

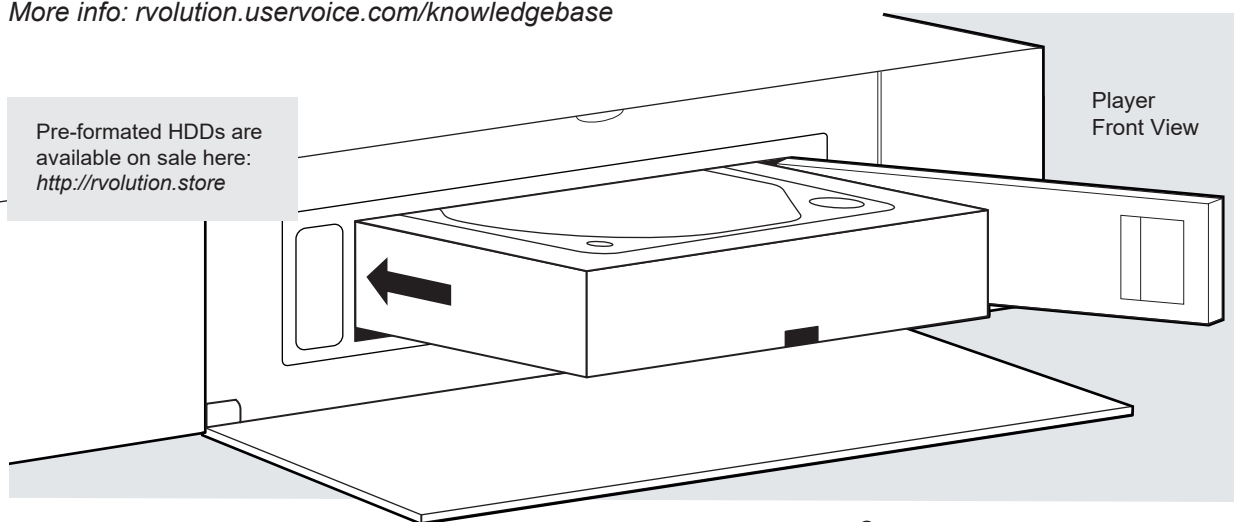

Open the tray and insert the HDD, keeping the connectors inside the bay.

## Using SD / MMC Memory Cards

To use a memory card, insert it in the memory card slot located on the left side of the media player. It will be detected as USB device (USB icon on the home page). Some SD memory cards may not be recognized by the player or may work incorrectly; in such case, please use a different model of memory card.

Use the RC buttons UP, DOWN, LEFT, RIGHT, OK, RETURN to navigate through the player menu. Use the **MENU** RC button to show the list of available commands. Use the **INFO** RC button during playback to show the INFO panel (duration, resolution, framerate, bitrate, etc.).

The Home Page features 2 main applications: **Explorer**, and **Video**.

## Explorer

Explorer is a File Manager. You can easily explore and launch playback of your music, pictures and video content. But Explorer is more than just a file explorer — it also provides many advanced multimedia features and a complete file management system.

## R\_video

R\_video is a media player, software and entertainment hub, featuring an impressive user interface with movie covers. With R\_video, you can experience your entire movie and TV series collection, browse and play your titles from local and network storage media, view cast information, download subtitles, play trailers and much more.

In order to start using the R\_video apps, you have to create a R\_volution account and register your device. First, connect your media player to Internet through Wi-Fi or Ethernet. Launch one app and select your language. Then, follow the on-screen instructions. If you have never used R\_volution before and if you don't have any R\_volution account, please click on **Create an account now**.

### Login

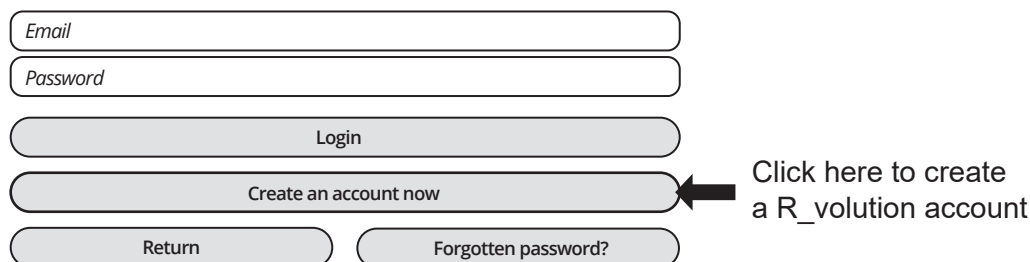

The login screen contains the following elements from top to bottom:

- An input field labeled "Email".
- An input field labeled "Password".
- A button labeled "Login".
- A button labeled "Create an account now", which is highlighted with a black arrow pointing to it from the right. To the right of the arrow is the text "Click here to create a R\_volution account".
- A button labeled "Return".
- A button labeled "Forgotten password?".

Then you will be prompted to enter your R\_volution Token number. The Token number is printed on a sticker stuck under the housing of the media player. You will only have to enter it once. Then all your account information will be saved in the internal memory of the media player. R\_volution needs this information in order to be able to register your collection (only the covers and not the films). The R\_cloud allows you to preserve your collection\*. In the event of a device failure, or the purchase of another R\_volution player, all you need to do is enter your credentials to access your collection and recover everything identically. R\_cloud also offers multiroom feature to access your collection of movies and shows from other R\_volution players in the house.

*\*for more info regarding the cloud service terms and conditions, please visit the official web site.*



## Accessing Network Drives And Access To The Player

This media player features a Samba client (SMB) to explore and playback your videos, pictures and music, located on your local network (NAS, computers, ...). The SMB Server is activated by default. You can access your media player entering **\\R\_VOLUTION** in the explorer of your computer or using the media player IP address as following: **\\192.168.1.15** (for instance). Then, enter **guest** as login and password. *In order to find the IP address of your player, go to: **SETTINGS / Ethernet Configuration**.*

More info about network access here: [rvolution.uservoice.com/knowledgebase](http://rvolution.uservoice.com/knowledgebase)

The media player also features a function called **R\_share**, based on Samba server technology. This allows you to access your video, pictures and music content, located on internal HDDs (or local drive connected in USB to the media player) from another R\_volution player through your local network. You can playback video contents, in 5 different rooms simultaneously, equipped with R\_volution media players. Thanks to **R\_share**, a NAS server or computer is not required to stream your media content in different rooms of your home. To use R\_share, please select **R\_share** instead of **Local drive** in the **Folder settings** of **R\_video**.

## How To Transfer Your Files Using Explorer

In addition to be a file browser, Explorer is also a complete file manager offering functions such as: Copy, Cut, Paste, Select, Select All, Delete and Rename. To access these functions, press the **MENU** button of the remote control.

## Slideshow Function

Explorer also offers a slideshow function with cross fades and transition effects. To manage the **Slide show delay** and **Transitions effect**, go to **Setup > Applications > Photo Viewer**. To access the Zoom options, press **Zoom** button. Then, press **1 time** for **Fit to Screen**, **2 times** for **Pixel to Pixel**, **3 times** for **Custom options**. Then, use **P+/-** to **Zoom In/Out** and **Arrows buttons** to move the focus. Press **Pause** button to pause the slideshow and press **Play** to **pause/play** the slideshow. Press **OK** to display the list of the pictures and direct access to any one of them. On this screen, press **7** for **Repeat** and **8** for **Shuffle** options.

## Video Properties

To view the complete technical information of the file being played, press the **INFO** button on the remote control. You will find in particular, the datarate, framerate, video and audio codec and format, size, resolution, and more...

## Video And Audio Playback Options

During playback, the **MENU** button on the remote control provides access to various video and audio playback options such as direct access to a precise playback position in time, zoom and ratio options, etc.

## R\_volution NAS Stats & options

The R\_video **MENU** provides access to the statistics of the R\_volution NAS (temperature of the drives, available space...) as well as music encoding options (MP3, AAC, and FLAC).

## How To Install A New App

To install a new app, please go to **Android Apps / AptoideTV**. You'll find many apps dedicated to media players that can be controlled by RC. You can also use **GooglePlay** but some apps may not be compatible with this media player. If you want to install an **APK** from a USB stick, please use **Explorer**.

## How to add a Favorite

To add movie or a folder as favorite, press **Menu** and select **Add to favorite** to add it to the favorite section.

## How to Create a Movie Collection in R\_video

Before starting, you must create a folder named **MOVIE** on your HDD. Then, place all your movies inside this folder. If you have TV shows, place them in a dedicated folder named **TV SHOWS**.

### Movies

1. On your NAS or HDD, please create a movie folder named **MOVIES**. Place all your movie files in it.
2. Your files should be named with the title of each movie. For example, the file of the movie "Metropolis" should be named "Metropolis.mkv". You can create subfolders in the folder **MOVIES** if you want.

### TV Shows / TV Series

1. On your NAS or HDD, please create a folder named **TV SHOWS**.
2. Then, create a subfolder for each TV Shows. You can create a subfolder for each season if you want. Then, place all your TV Show episodes in it.
3. Your episodes must be named as: "TVShowName s01e01" ("TVShowName 1x01" also supported). For the special episodes, please name them as: "s00e01".

### Connection

|             |   |
|-------------|---|
| Accounts    | <input type="text" value="my.email@mailbox.com"/> |
| Servers     | <input type="text" value="R_cloud"/>              |
| Collections | <input type="text" value="Collection 1"/>         |

Start your player. On the main page, click on the first button named **VIDEO**. Choose your language and enter your login. *If you do not have any R\_video account, please go to the page 14.*

Then, click on the button **Connection** located on the bottom of the window.

On the **Folder configuration** window, please click on **Add a folder containing movies** (or TV Shows). If your files are located on a local storage, please click on **Local drives**. If you want to share your video contents with others R\_volution players through your local network, click on **R\_share**. Then click on the storage name. Next, browse it and go inside the Movies (or TV Shows) folder. Finally, when you are in the folder **MOVIES** (or TV SHOWS) click on **Add this folder** button located on the top of the window.

**WARNING! Do not add all your subfolders. You should just add your "MOVIES" folder containing all your movies. If you own a NAS, please place your folders MOVIES and TV SHOWS inside the shared folder VIDEO. Do not place your folders MOVIES and TV SHOWS in the root folder of your NAS.**

Your folder will be added in the MOVIE folder list (or TV SHOW). You can check the path by looking on the **generated path** located between "MOVIES" button and **EDIT** button. Your path should stop to the "MOVIES" folder (or "FILMS" folder). If your path is incorrect, you can modify it by using the **Edit** button. Press **Delete** button to delete the folder from R\_video. *(Don't worry! Your movies will not be deleted)*. If you want to add another folder containing movies or TV Shows, please click on the dedicated button.

### Folders

|  |   |                                     |                                       |
|--|---|-------------------------------------|---------------------------------------|
| <input type="button" value="Movies"/>                                  | <input type="text" value="/storage/HDD/Films"/> | <input type="button" value="Edit"/> | <input type="button" value="Delete"/> |
| <small>Storage ID: fs3sho54suey-ya55h4st7e-syot563lj3a</small>         |   |                                     |                                       |
| <input type="button" value="Add a folder containing movies"/>          |   |                                     |                                       |
| <input type="button" value="Add a folder containing TV shows"/>        |   |                                     |                                       |
| <input type="button" value="Add a folder containing personal movies"/> |   |                                     |                                       |

Then, press **RETURN** if you don't want to add another folder containing movies. R\_video will start to scan your folders and analyse your video contents. You can see the current scan task in a dedicated panel. To close the current task panel, press the **RETURN** button of your RC. If you close it, you can display it again through the **MENU** button of your RC.

**Done!** Now you can enjoy your R\_video collection! To access to the configuration panel again, press the **MENU** button on your remote control. In the configuration panel, you'll find many options such as: language (GUI and identification), translations, templates, top movie cover, glass effect, parental control, identification on startup and other options, terms to exclude, token and other account administration.

**More info here:** [rvolution.uservoice.com/knowledgebase](http://rvolution.uservoice.com/knowledgebase)

## R\_video

The homepage of R\_video is composed of 2 parts. The left part offers access buttons to modules. By default, a number of modules are displayed such as: **ALL, MOVIES, SERIES, RECENT, CATEGORIES, ...** It is possible to delete or add modules using the **MENU** button on the remote control. It is also possible to display the contents of a module or category at your choice in the main part (showcase). By default, the **NEXT** module is proposed. This module displays the movies or episodes currently playing. In case you have completed a TV episode, the following episode is proposed. In the case of a saga, the following movie is displayed. To delete an episode or movie from the **NEXT** module, select it and press the **MENU** button and click **Remove from Showcase**.

/storage/HDD/Films  
Storage ID: 0000000000000000

If you get a wrong storage ID with « 000000000 », it means that R\_video cannot write on the drive due a defective disk sector. Please format it again.

To access to additional features, press **MENU** button of your RC.

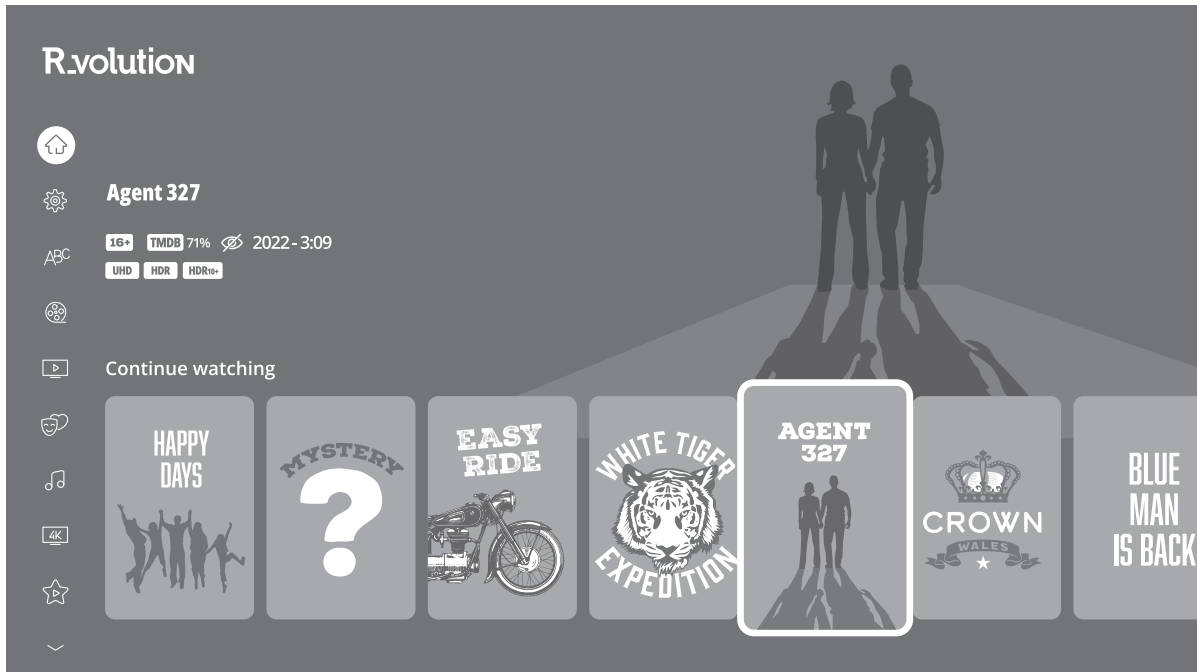

## How to Identify a Movie / Episode

When you add a movie file to your **Movies** folder, R\_video will automatically index it during the next restart of the application. To force the identification process, please press **MENU** of your remote control, then click on **Identify** option.



### Identification

- Start identification ←
- No video to identify

## How to Delete a Movie / Episode

When you delete a movie file from your 'Movies' folder, R\_video automatically removes its cover and descriptive page from your R\_video collection during the next analysis. You can manually remove a movie using the **Delete** option located in the R\_video menu (contextual actions).



### Edition

- Delete... ←
- Categories

## How to Identify Unidentified Movies & TV Shows

Even if your files are not named correctly with the name of the film (or TV show), R\_video can identify it but only if a R\_video user previously identified it manually. If you are living in a country where R\_video is not yet popular, which could have happened often at the beginning, mostly if you are using a R\_video NAS Rip because the generated files are rarely named correctly. But day after day, R\_video\_DB will become more and more reliable as users will manually identify files of movies and TV series.

Press **MENU** of the RC and select **X to Identify**. You'll see the list of the files that are not identified. Then, click on the button named **Identify...** On the **Identify window**, please enter again the movie name.

You can also enter the IMDB, TMDb or TVDB ID code to identify your movie or your TV show. On TMDb, TVDB or IMDB, the ID code is located in the URL of the movie page. For instance, the URL of the movie "Metropolis" will be "http://www.imdb.com/title/tt0017136/". Enter the ID number "tt0017136" into the field instead of the title name. Then press the "Search" button. R\_video will find the right movie at 100%. If your movie or TV show does not exist on TMDb or TVDB, you can add it by creating an account on it.

## 3D, 4K and UHD Files

The 3D BD ISO, UHD ISO and 4K ISO files as well as BDMV folders for 3D and 4K UHD cannot be always identified automatically. In this case, to identify these containers, please add the following tags in the name as follows:

**3D Files:** "3D". (For example: "Metropolis.3D.iso").

**UHD Files:** "UHD" or "ULTRAHD" or "ULTRA-HD". (For example: "Metropolis.UHD.iso").

**4K Files:** "4K" or "4096" (For example: "Metropolis.2160x4096.iso").

## How to Change a Picture (Poster or Background)

To change the poster or the background of a movie or TV show, press **MENU** button of your remote control, then click on **Change the picture** option using **OK** button of your R\_video remote control. Then, click on the poster or background of your choice. If you see a R\_video DB banner, it means that this picture is part of R\_video movie cover database.

## Multiple Hard Drives

R\_video is able to mix the content of several sources. For instance, one collection can contain movies located on 2 hard drives and one NAS. If you are using multiple hard drives, R\_video is able to detect if the drives are accessible or not. When you launch a movie but the drive containing the movie is not connected, R\_video will show a popup window asking to insert the dedicated drive.

## Parental Control

To tag a movie as **Allow for children**, select a movie (or a group of movies), then press the **MENU** button on the RC and click on **Allow for children**. Then, enter a 4-digit pin code.

### Parental code

Please enter a 4-digit pin code.  
This code will allow you to lock your collection and restrict access to movie tagged "Allowed for children".



## Personal Categories

By default, the movies and TV shows are automatically associated to categories. But you can create your own categories and associate manually your movies. To create a category, go to **Categories**, then press **MENU** and click on **Create a category**. Then, enter a name and choose an icon. The contextual menu gives also access to additional options such as: **modify the position**, **edit** or **remove**.



## R\_video On Start-Up

To activate this function, press **MENU**, then go to **Settings**, click on the **second tab** and switch **ON** the option in the list.

### Auto-start

Auto launch R\_video on start-up  
↑

## Filter and Sort

To sort your movies, press **MENU**, then go to Filter and sort. Then click on the **first item**. Then select the sorting: **A to Z**, **Z to A**, **Release date**, **Duration**, **Addition...** To filter your movies, please click the following options: **Seen**, **Ongoing**, or **Not seen**.

### Filters

-  Decreasing Release date
- Seen videos
- Ongoing videos
- Not seen videos

## Search Engine

To search a movie, TV show or even movies from specific actor or director, press **MENU**, then on the first row, click on the search engine. Then, enter your search (title, actor, director). The results will be filtered by **Movie**, **TV Show**, **Actor** and **Director**.

## Sagas / Groups

The films from sagas are automatically placed in groups and sorted by release date. A saga cover dedicated to the collection is associated with the group and movies are displayed in a stunning carousel with great 3D motion effects!

## Show Special Top Banner

R\_video is able to auto detect some formats and to add top banner such as 4K Ultra HD Blu-ray, Blu-ray or DVD. But it is also possible to add special top banners such as Director's Cut, Special Edition, Disc 2, Bonus Disc, and many others. To add a special top banner on a cover, press **MENU**, then go to **Edit**, then go to the second tab **Technical Information**, then go to **Special Banner** and select the special banner you want to associate with your cover.

## Subtitle Display Options During Playback

To change the subtitle display options such as vertical position, size and color, press the **Subtitle** button on the R\_video remote control during video playback, then go to **Settings** and change the desired option. To change the **vertical position**, use the buttons **UP / DOWN**. To change the **size**, use the buttons **P+ / P-**. To change the **color**, use the buttons **1-6**. To add external subtitle, please use the same name as the video file as follows: *Metropolis.mkv / Metropolis.srt*

## Zoom and Aspect Ratio Settings During Playback

To modify the aspect ratio or to zoom on the picture during playback, press the defollowing button: 

## Media Info During Playback

To display the media info and and various info such as the bitrate, the resolution, the frequency, etc., please press **INFO** button during playback.

## Generate a CSV File From a R\_volution Collection

If you want to extract all the data from your collection for processing in an external management software or Excel table, this feature should be able to help you. In order to generate a .csv file from your collection, press the **MENU** button on your remote control, and go to **Settings**. Then, in the second tab, scroll down to select **Generate a .csv file from the collection**. A CSV file will be sent to the email adress of your R\_volution account.

## Add a Category in the Menu

On the R\_video homepage, press the **MENU** button on your remote control, and go to **Add a module**. Choose from the list of modules the category you want to highlight in the Menu.

## Token Error Message "Account / token already used"

When you encounter the message **Account / token already used** you need to release the token in order to use it. If you are not able to do it by yourself, contact us by sending us a photo of the sticker under the media player with the token number. We will release it for you.

## Firmware Upgrade

Usually, if a new firmware is available, you will be informed on the startup of the player. To access the Firmware upgrade page and manually launch the update of firmware online, go to **Setup > Miscellaneous > Firmware Upgrade**. You will see the current firmware version. Click on **Check Available Update**. If a new version is available, you will be able to download it and install it. If there is no new firmware version available, a popup windows will appear to confirm it. To manually upgrade the firmware using a USB flash drive, please visit the Rvolution Knowledge Base:

[rvolution.uservoice.com/knowledgebase](http://rvolution.uservoice.com/knowledgebase)



### DISCLAIMER

On some cases — especially if you come from a more recent firmware — during the process, the TV screen can switch to **GREEN** or **BLACK** for a while. This is normal! Please absolutely not restart or switch off your player during the full process. In such case, please wait 10 min before to restart your media player.

## Factory Reset

In case of problem, try turn OFF your media player and unplug the power cable during 10 min. It could solve the problem. If it does not help, please try the following procedure. Be careful, however. This will reset all your settings and account information. But you will not lose your movie collection.

1. Go to **Setup > General**
2. Click **Reset Settings** button, then click on **Reset settings** to confirm the procedure.
3. Please wait during the reset process.

**Warning!** Do not restart or switch off your player during the full process

## Hardware Reset

If you do not get any video signal, you can boot into Recovery menu:

1. Start the media player.
2. During power-on press and hold **Reset** button located on the back of the media player using a paper clip.
3. Then do "**Wipe data**".

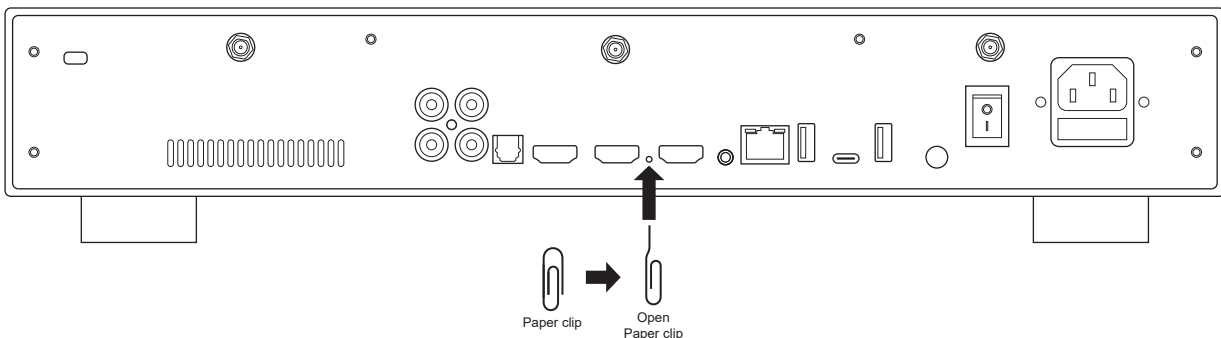

# R.volution

[rvolution.com](http://rvolution.com) / [rvolution.store](http://rvolution.store)





















































