

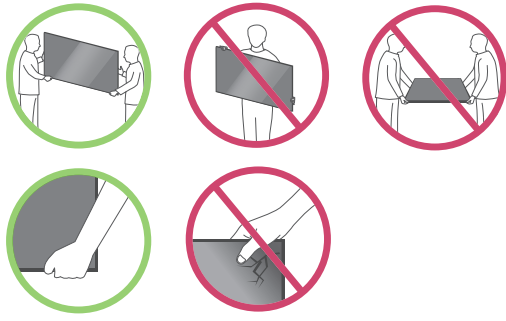

75UP75\*

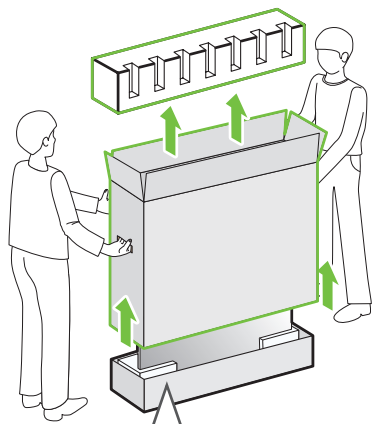

1



2

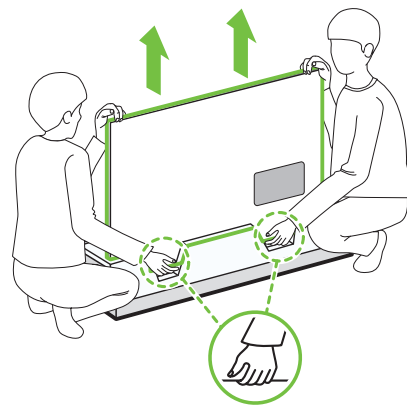

3

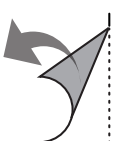
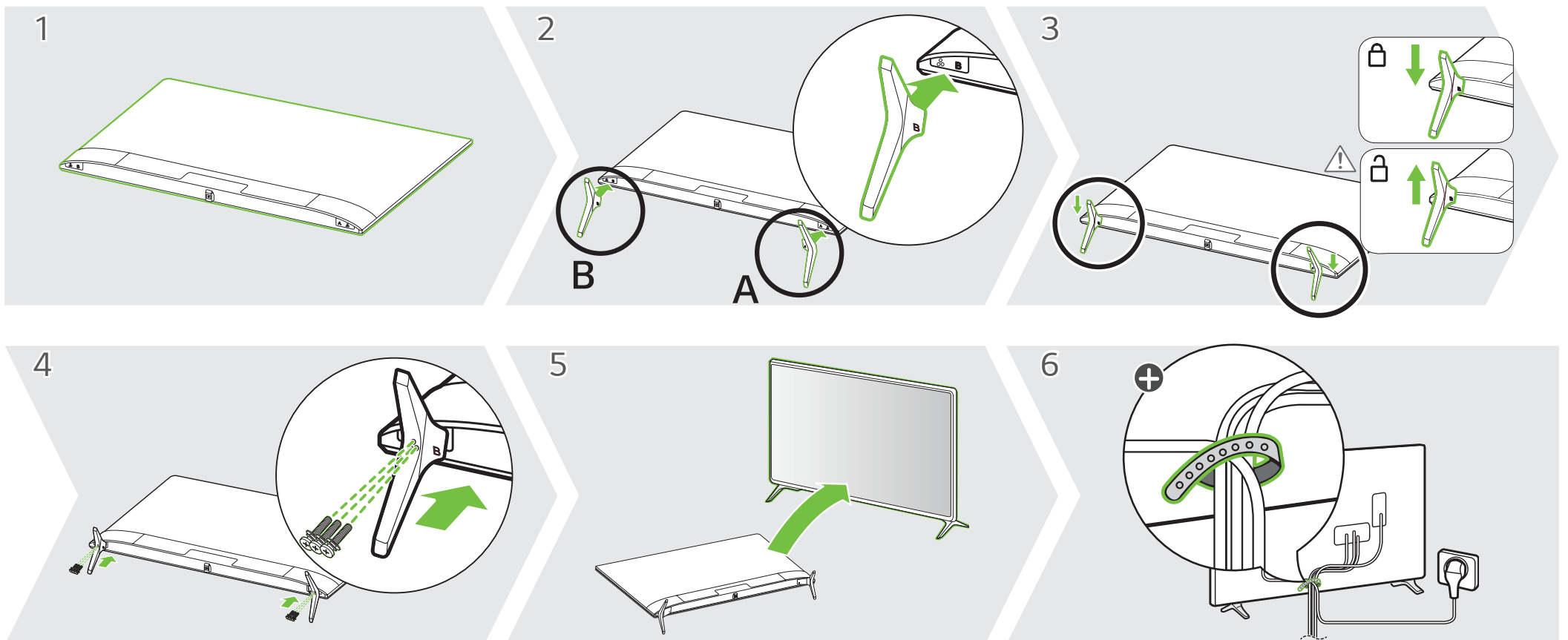
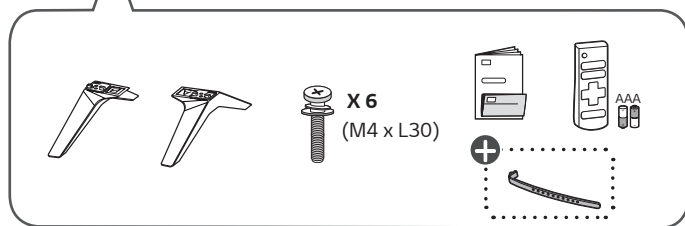
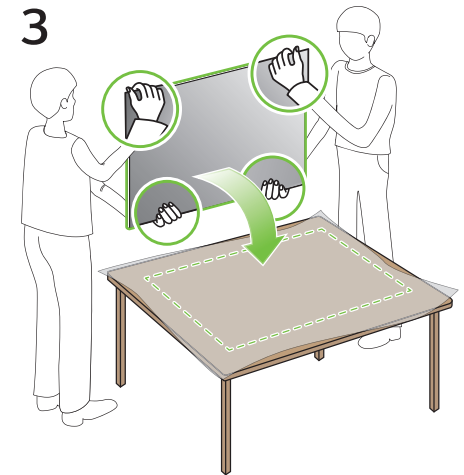

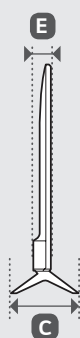
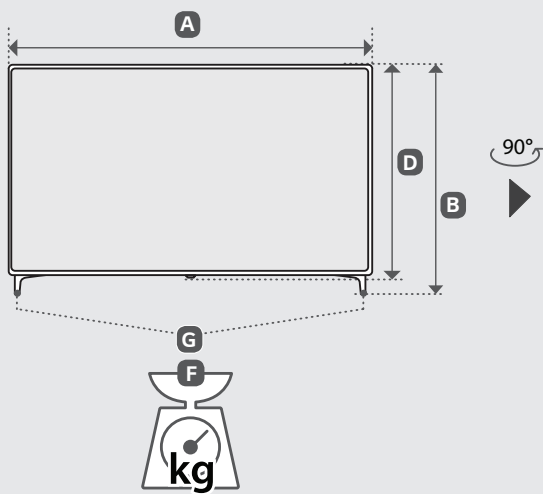
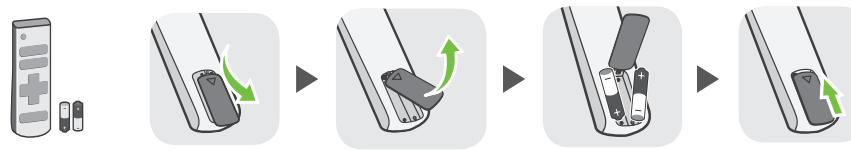
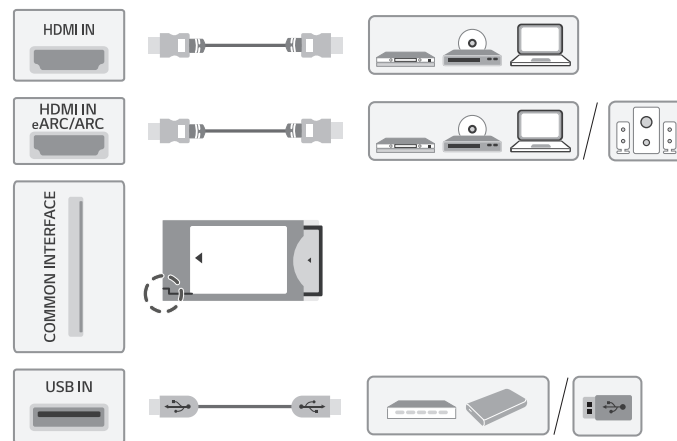
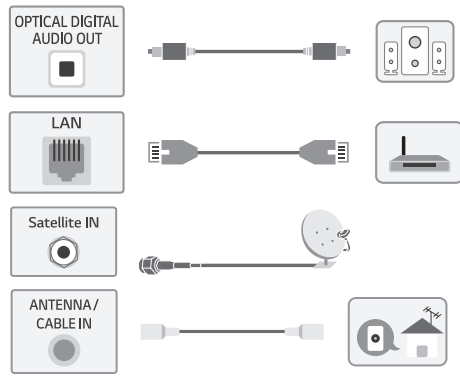

	A	B	C	D	E	F	F-G
	(mm)					(kg)	
75UP75003LC 75UP75006LC 75UP75009LC	1693	1048	345	978	88.8	35.4	34.6
Power requirement	AC 100-240 V ~ 50 / 60 Hz						



- English · Read Safety and Regulatory.
- Deutsch · Lesen Sie die **Sicherheitsanweisungen und Richtlinien**.
- Français · Lire le document **Sécurité et mesures réglementaires**.
- Italiano · Leggere il manuale **Sicurezza e normative**.
- Español · Leer **Seguridad y normativa**.
- Português · Ler informações sobre a **Segurança e Regulamentos**.
- Nederlands · **Veiligheidsinformatie en regelgeving** lezen.
- Ελληνικά · Διαβάστε τις **οδηγίες για την ασφάλεια και τους κανονισμούς**.
- Slovenščina · Preberite **varnostne in regulativne vidike**.

- Hrvatski · Pročitajte **Sigurnost i usklađenost s propisima**.
- Shqip · Lexoni paragrafin "**Siguria dhe rregullimi**".
- Bosanski · Pročitajte dio **Sigurnost i propisi**.
- Македонски · Прочитајте за **безбедноста и регулативата**.
- Svenska · Läs **Säkerhet och föreskrifter**.
- Magyar · Biztonsági szabályzat megtekintése.
- Polski · Prosimy o przeczytanie **Zasad bezpieczeństwa i uwag dotyczących przepisów**.
- Česky · Přečtěte si část **Bezpečnost a zákonné předpisy**.
- Slovenčina · Prečítajte si **bezpečnostné a regulačné informácie**.

- Română · Consultați manualul referitor la **siguranță și reglementare**.
- Български · Прочетете **Безопасност и регулаторни стандарти**.
- Eesti · Lugege **ohutus- ja normatiivteavet**.
- Lietuvių k. · Perskaitykite **Saugos ir norminius reikalavimus**.
- Latviešu · Izlasiet sadaļu **Drošība un normatīvi**.
- Srpski · Pročitajte odeljak **Bezbednost i regulatorna pitanja**.
- Norsk · Les **sikkerhet og forskrifter**.
- Dansk · Læs **sikkerhed og lovmæssige bestemmelser**.
- Suomi · Lue **Turvallisuus ja säännökset** -osio.

⊕ : Depending on model / Abhängig vom Modell / Selon le modèle / In base al modello / En función del modelo / Dependendo do modelo / Afhankelijk van het model / Αν λογα με το μοντ λο / Odvisno od modela / Típusfüggő / Zależnie od modelu / Závisí na modelu / V závislosti od modelu / În funcție de model / В зависимости от модели / Sõltub mudelist / Priklauso nuo modelio / Atkarībā no modeļa / U zavisnosti od modela / Ovisno o modelu / Né varási tē modelīt / Ovisno o modelu / во зависисот од моделот / Beroende på modell / Avhengig av modell / Afhængigt af modellen / Mallin mukaan