

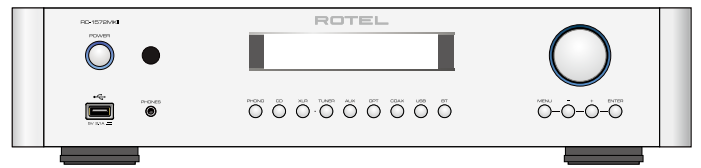

ROTEL®



RC-1572MKII

Stereo Control Amplifier

Amplificateur de Contrôle Stéréo

Stereo-Vorverstärker

Preamplificador Estereofónico

Stereo-regelverstärker

Preamplificatore Stereo

Stereokontrollförstärkare

Предварительный стерео усилитель

Owner's Manual

Manuel de l'utilisateur

Bedienungsanleitung

Manual de Instrucciones

Gebruikershandleiding

Manuale di istruzioni

Instruktionsbok

Инструкция пользователя

Important Safety Instructions

Notice

The RS232 connection should be handled by authorized persons only.

WARNING: There are no user serviceable parts inside. Refer all servicing to qualified service personnel.

WARNING: To reduce the risk of fire or electric shock, do not expose the unit to moisture or water. Do not expose the unit to dripping or splashing. Do not place objects filled with liquids, such as vases, on the unit. Do not allow foreign objects to get into the enclosure. If the unit is exposed to moisture, or a foreign object gets into the enclosure, immediately disconnect the power cord from the wall. Take the unit to a qualified service person for inspection and necessary repairs.

Read these instructions.

Keep these instructions.

Heed all warnings.

Follow all instructions.

Do not use this apparatus near water.

Clean only with dry cloth.

Do not block any ventilation openings. Install in accordance with the manufacturer's instructions.

Do not install near any heat sources such as radiators, heat registers, stoves, or other apparatus (including amplifiers) that produce heat. Do not defeat the safety purpose of the polarized or grounding-type plug. A polarized plug has two blades with one wider than the other.

A grounding type plug has two blades and a third grounding prong.

The wide blade or the third prong are provided for your safety. If the provided plug does not fit into your outlet, consult an electrician for replacement of the obsolete outlet.

Protect the power cord from being walked on or pinched particularly at plugs, convenience receptacles, and the point where they exit from the apparatus.

Only use attachments/accessories specified by the manufacturer.

Use only with the cart, stand, tripod, bracket, or table specified by the manufacturer, or sold with the apparatus.

When a cart is used, use caution when moving the cart/apparatus combination to avoid injury from tip-over.



Unplug this apparatus during lightning storms or when unused for long periods of time.

Refer all servicing to qualified service personnel. Servicing is required when the apparatus has been damaged in any way, such as power supply cord or plug is damaged, liquid has been spilled or objects have fallen into the apparatus, the apparatus has been exposed to rain or moisture, does not operate normally, or has been dropped.

The apparatus should be used in non tropical climate.

The ventilation should not be impeded by covering the ventilation openings with items, such as newspapers, table-cloths, curtains, etc.

No naked flame sources, such as lighted candles, should be placed on the apparatus.

Touching uninsulated terminals or wiring may result in an unpleasant sensation.

You must allow a minimum 10 cm or 4 inches of unobstructed clearance around the unit.

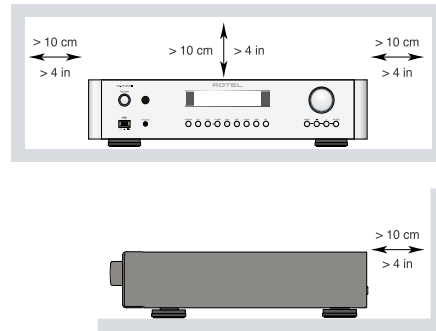

WARNING: The rear panel power cord connector is the mains power disconnect device. The device must be located in an open area that allows access to the cord connector.

The unit must be connected to a power supply only of the type and voltage specified on the rear panel. (USA: 120 V/60Hz, EC: 230V/50Hz)

Connect the component to the power outlet only with the supplied power supply cable or an exact equivalent. Do not modify the supplied cable. Do not use extension cords.

The mains plug is the disconnect of the unit. In order to completely disconnect the unit from the supply mains, remove the main plug from the unit and the AC power outlet. This is the only way to completely remove mains power from the unit.

The batteries in the remote control should not be exposed to excessive temperature such as sunshine, fire or other heat sources. Batteries should be recycled or disposed as per state and local guidelines.

This device complies with Part 15 of the FCC Rules. Operation is subject to the following to conditions: (1) This device may not cause harmful interference, and (2) this device must accept any interference received, including interference that may cause undesired operation.

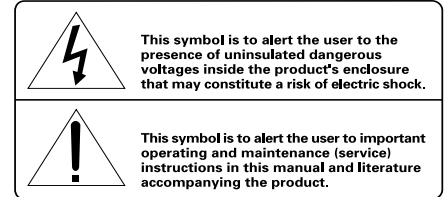
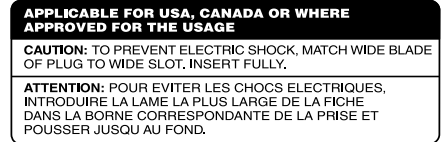

Rotel products are designed to comply with international directives on the Restriction of Hazardous Substances (RoHS) in electrical and electronic equipment and the disposal of Waste Electrical and Electronic Equipment (WEEE). The crossed wheeled bin symbol indicates compliance and that the products must be appropriately recycled or processed in accordance with these directives.



This symbol means that this unit is double insulated. An earth connection is not required.

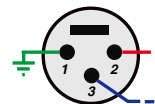

Pin Assignments

Balanced Audio (3 pole XLR):
Pin 1: Ground / Screen
Pin 2: In phase / +ve / Hot
Pin 3: Out of phase / -ve / Cold



Figure 1: Controls and Connections
 Commandes et Branchements
 Bedienelemente und Anschlüsse
 Controles y Conexiones

Bedieningselementen en aansluitingen
 Controlli e connessioni
 Kontroller och anslutningar
 Органы управления и разъемы

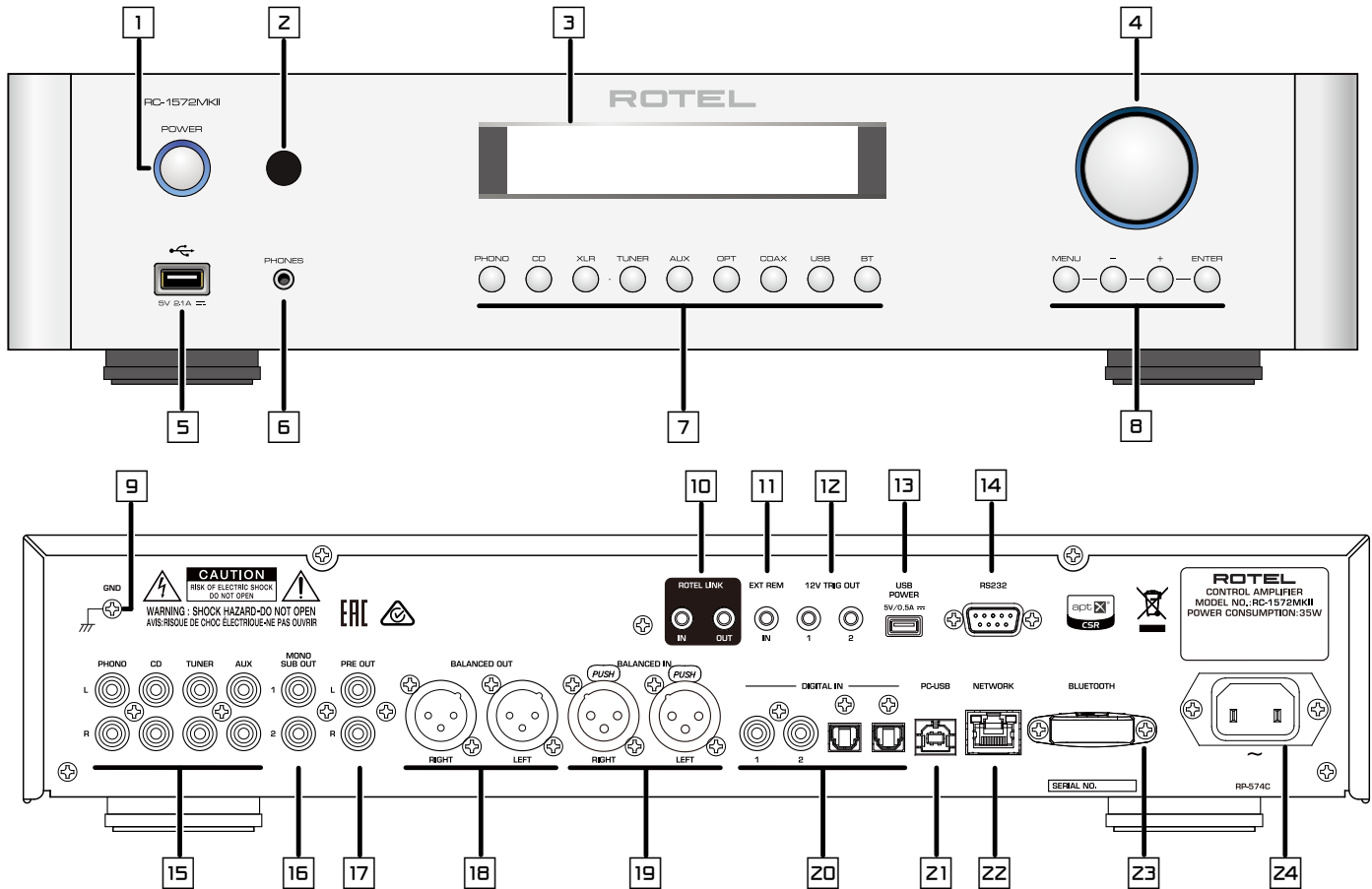

Figure 2 : RR-AX93 Remote Control
 Télécommande infrarouge RR-AX93
 Fernbedienung RR-AX93
 Mando a Distancia RR-AX93

Afstandsbediening RR-AX93
 Telecomando RR-AX93
 RR-AX93 fjärrkontroll
 Пульт ДУ RR-AX93

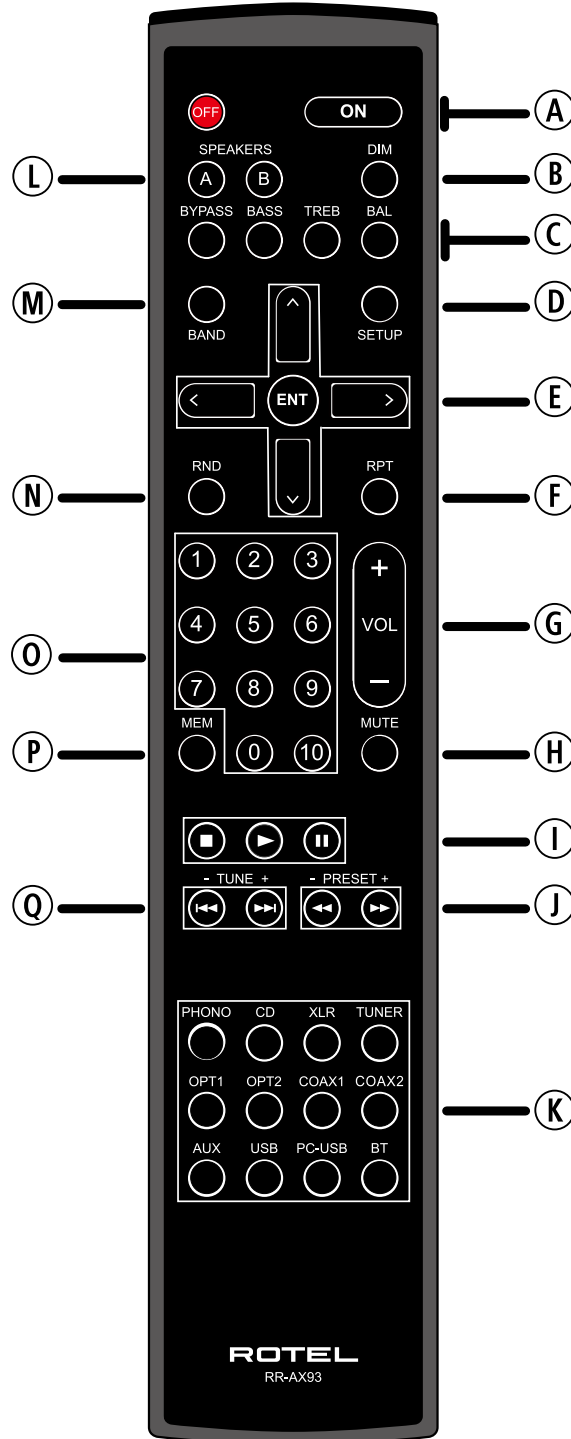

Figure 3 : Analog Input and Output Connections
 Branchements des entrées et sorties analogiques
 Analoge Ein- und Ausgangsanschlüsse
 Entradas y Salidas Analógicas

Analoge ingangen en uitgangen
 Collegamenti ingressi ed uscite analogici
 Anslutningar för analoga in- och utgångar
 Аналоговые входные и выходные разъемы

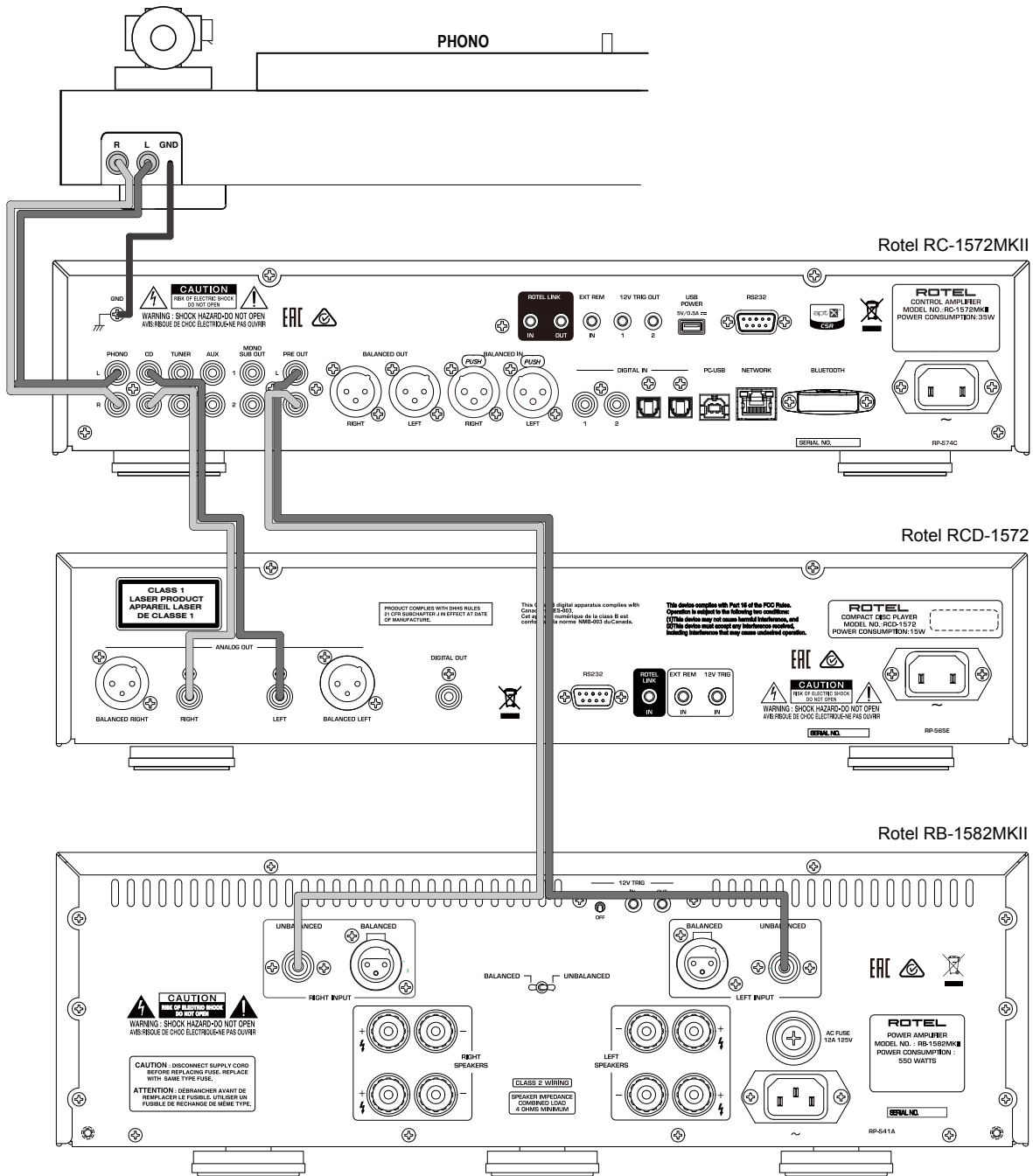

Figure 4 : **Balanced (XLR) Input and Output Connections**
Branchements des entrées et sorties symétriques (XLR)
Symmetrische (XLR)-Ein- und Ausgangsanschlüsse
Entradas y Salidas Balanceadas (XLR)

Gebalanceerde ingangen (XLR) en uitgangen
Ingressi ed uscite analogici bilanciati (XLR)
Balanserade in- och utgångar (XLR)
Балансные (XLR) входные и выходные разъемы

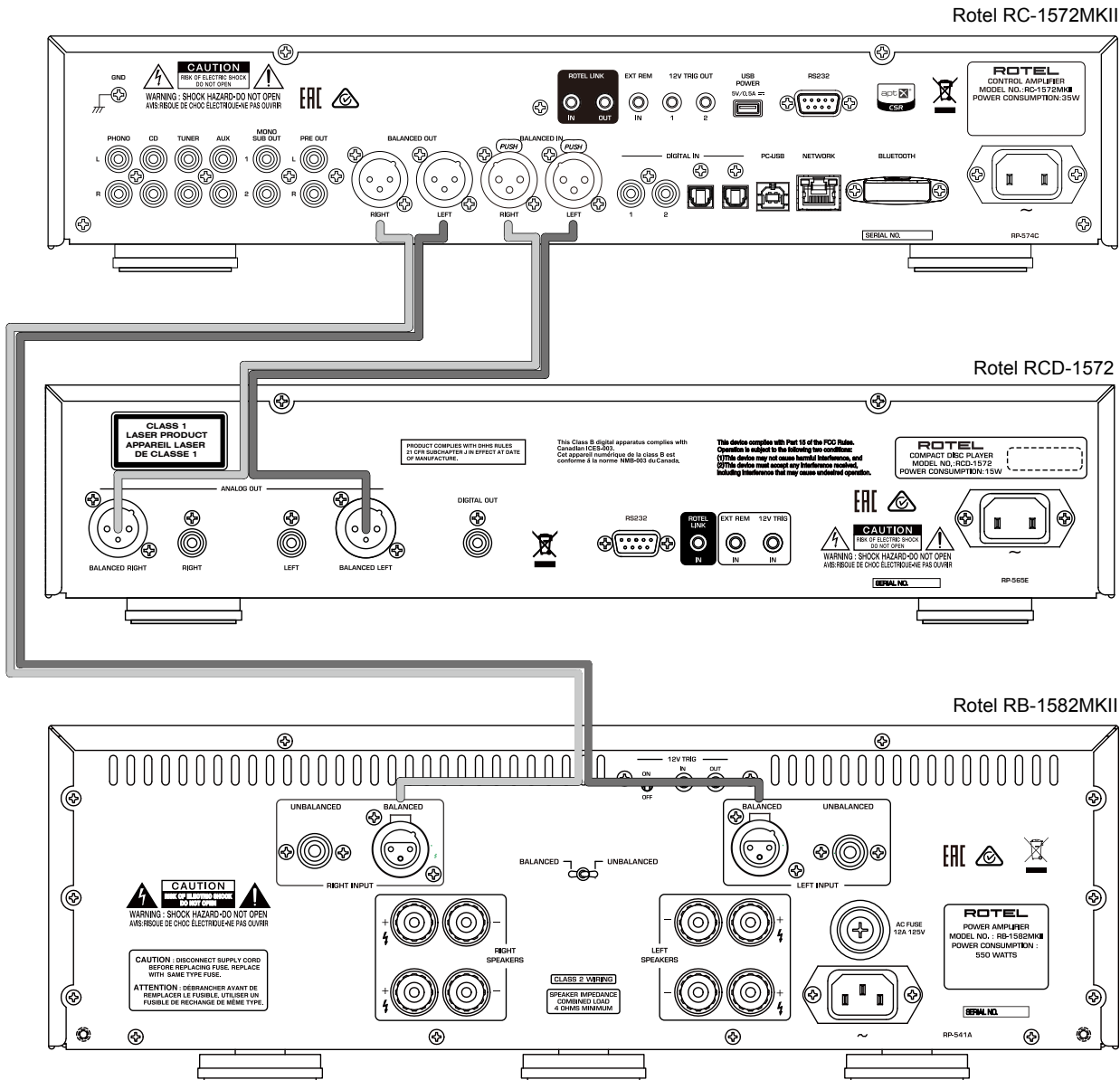
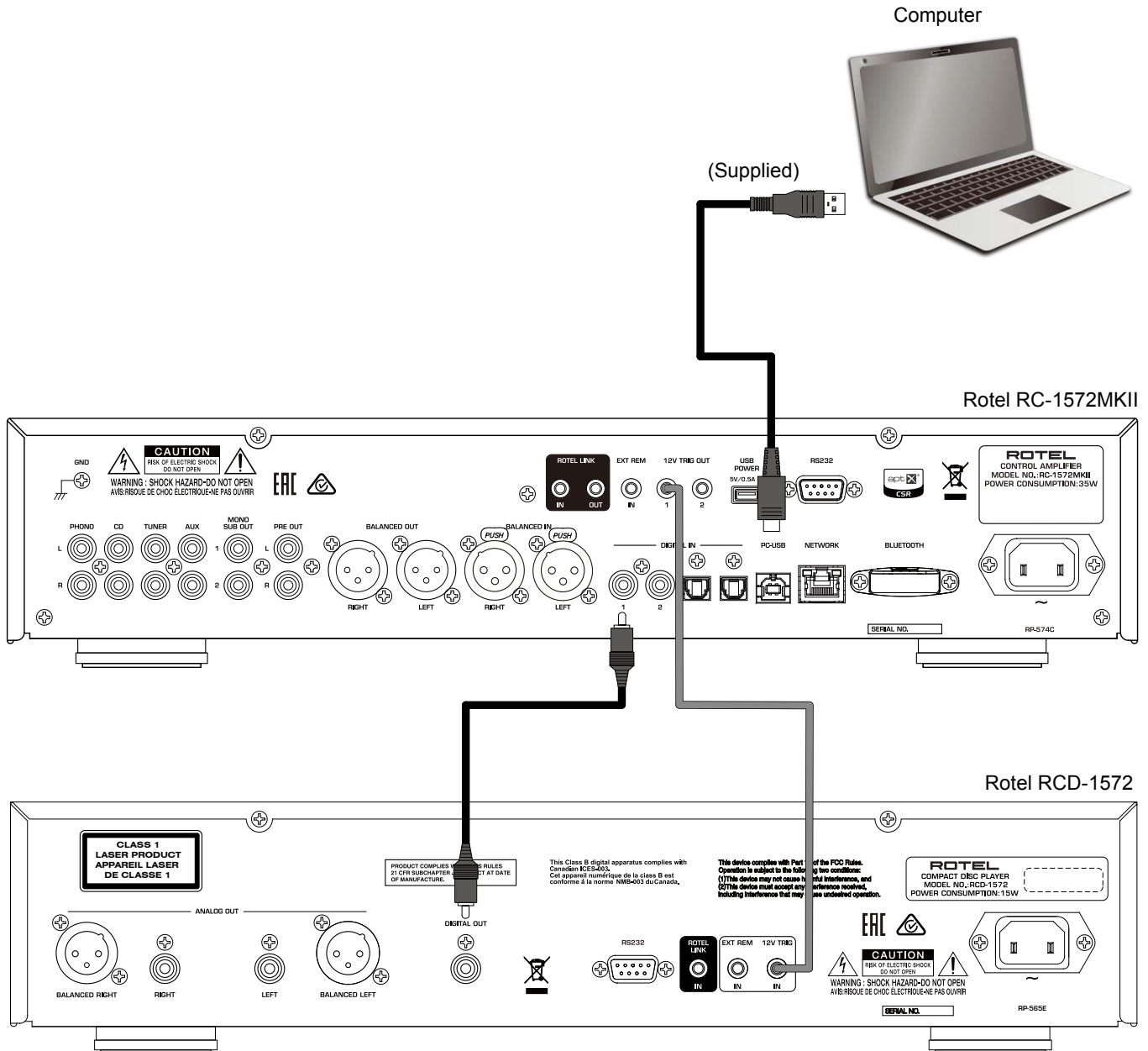

Figure 5 : Digital Input and 12 Volt Trigger Out Connections
 Entrées numériques et Branchements des sorties trigger 12 V
 Anschlussdiagramm (Digitaleingänge, 12V-Trigger-Ausgänge)
 Entrada Digital y Conexiones de Salida para Señal de Disparo de 12 Voltios
 Digitale ingangen en 12V-triggeruitgangen
 Collegamenti ingressi digitali e segnali Trigger 12 V
 Anslutningar för digitala ingångar och 12-volts styr signaler
 Цифровой вход и выход 12-В триггерного сигнала



Important Notes

When making connections be sure to:

- ✓ Turn off **all** the components in the system **before** hooking up **any** components, including loudspeakers.
- ✓ Turn off **all** components in the system **before** changing **any** of the connections to the system.

It is also recommended that you:

- ✓ Turn the volume control of the amplifier all the way down **before** the amplifier is turned **on or off**.

Remarques importantes

Pendant les branchements, assurez-vous que :

- ✓ **Tous** les maillons sont éteints **avant** leur branchement, **quels qu'ils soient**, y compris les enceintes acoustiques.
- ✓ Éteignez **tous** les maillons **avant** de modifier **quoi que ce soit** au niveau de leurs branchements, quels qu'ils soient.

Il est également recommandé de :

- ✓ Toujours baissez le niveau sonore via le contrôle de volume, **avant d'allumer ou d'éteindre** l'amplificateur.

Wichtige Hinweise

Achten Sie beim Herstellen der Verbindungen auf Folgendes:

- ✓ Schalten Sie **alle** Komponenten im System ab, **bevor** Sie Geräte (einschließlich Lautsprecher) anschließen.
- ✓ Schalten Sie **alle** Komponenten im System ab, **bevor** Sie Anschlüsse im System verändern.

Ferner empfehlen wir, dass

- ✓ Sie die Lautstärke herunterdrehen, **bevor** Sie den Verstärker **ein-** oder **abschalten**.

Notas Importantes

Cuando realice las conexiones, asegúrese de que:

- ✓ Desactiva **todos** los componentes del equipo, cajas acústicas incluidas, **antes** de conectar **cualquier nuevo componente** en el mismo.
- ✓ Desactiva **todos** los componentes del equipo **antes** de cambiar **cualquier conexión del mismo**.

También le recomendamos que:

- ✓ Reduzca el nivel de volumen de su amplificador a cero **antes** de **activarlo o desactivarlo**.

Héél belangrijk

Bij het maken van de verbindingen:

- ✓ Zorg dat niet alleen de RC-1572MKII, maar de **gehele** installatie uitstaat, als nog niet **alle** verbindingen gemaakt zijn.
- ✓ Zorg dat niet alleen de RC-1572MKII, maar de **gehele** installatie ook uitstaat, **als** u verbindingen gaat **wijzigen**.

Wij raden u ook aan om

- ✓ de volumeregelaar van de (voor)versterker geheel dicht te draaien (volkomen linksom) **wanneer** u uw eindversterker **aan- of uitzet**.

Note importanti

Quando effettuate i collegamenti assicuratevi di:

- ✓ Spegnerne **tutti** i componenti del sistema **prima** di collegare **qualsiasi** componente, inclusi i diffusori.
- ✓ Spegnerne **tutti** i componenti del sistema **prima** di modificare **qualsiasi** connessione nel sistema.

Vi raccomandiamo inoltre di:

- ✓ Portare il volume a zero **prima** di **accendere o spegnere** l'amplificatore.

Viktigt

Tänk på följande när du gör anslutningar:

- ✓ Stäng av **alla** apparater i anläggningen **innan** du ansluter nya komponenter eller högtalare.
- ✓ Stäng av **alla** apparater i anläggningen **innan** du ändrar någon anslutning.

Du rekommenderas också:

- ✓ Vrida ner volymen på förförstärkaren helt och hållet **innan** förstärkaren slås **på eller av**.

Важные замечания





































Перед подсоединением:

- ✓ Выключите **все** компоненты, включая колонки.
- ✓ Выключите **все** компоненты в вашей системе, прежде чем что-то в ней **менять**.

Рекомендуется также:

- ✓ Вывести громкость усилителя на **минимум**, перед тем как **включать или выключать** его.

Contents

Important Safety Instructions	2
Figure 1: Controls and Connections	3
Figure 2: RR-AX93 Remote Control	4
Figure 3: Analog Inputs and Output Connections	5
Figure 4: Balanced (XLR) Input and Output Connections	6
Figure 5: Digital Inputs Connection and 12 Volt Trigger Out Connection	7
Important notes	8
About Rotel	9
Getting Started	9
A Few Precautions	10
Placement	10
Cables	10
The RR-AX93 Remote Control	10
Remote Control Batteries	10
AC Power and Control	10
AC Power Input 	10
Power Switch and Power Indicator  	10
12V Trigger Connection 	10
Input Signal Connections	11
Phono Input  and Ground Connection 	11
Line Level Inputs 	11
Balanced (XLR) Inputs 	11
Digital Inputs 	11
Output Connections	11
MONO SUB Out output 	11
Preamp Output 	11
Balanced (XLR) Output 	11
Headphone Output 	11
Remote Sensor 	11
Display 	11
Front USB Input 	11
APT-X Bluetooth Connection 	11
Rear USB Power port 	11
Audio Controls	12
Volume Control  	12
Balance Control  	12
Tone Control Bypass  	12
Bass and Treble Tone Controls  	12
Function Control  	12
Dimmer Control	12
Display Dimmer  	12
POWER LED Dimmer 	12
Rotel Link 	12
EXT REM IN Jack 	12
RS232 	12
PC-USB Input 	13
Network Connection 	13
Settings Menu	13
Troubleshooting	15
Power Indicator Is Not Illuminated	15
Fuse replacement	15
No Sound	15
Cannot Connect via Bluetooth	15
Playable Audio Format	15
Specifications	16

About Rotel

Our story began over 50 years ago. Over the decades, we have received hundreds of awards for our products and satisfied hundreds of thousands of people who take their entertainment seriously - like you!

Rotel was founded by a family whose passionate interest in music led them to manufacture high-fidelity components of uncompromising quality. Through the years, that passion has remained undiminished and the family goal of providing exceptional value for audiophiles and music lovers, regardless of their budget, is shared by all Rotel employees.

Rotel's engineers work as a close team, listening to, and fine tuning, each new product until it reaches their exacting musical standards. They are free to choose components from around the world in order to make that product the best they can. You are likely to find capacitors from the United Kingdom and Germany, semiconductors from Japan or the United States, while toroidal power transformers are manufactured in Rotel's own factory.

We all have concerns about our environment. And, as more and more electronics are produced it is especially important for a manufacturer to do all it can to engineer products that have a minimum impact on the environment.

At Rotel, we are proud to do our part. We have reduced the lead content in our products by using special lead-free ROHS solder and components. Our engineers continually strive to improve power supply efficiency without compromise to quality. When in standby mode Rotel products use minimal power to meet global Standby Power Consumption requirements.

The Rotel factory is also doing their part to help the environment through constant improvements to product assembly methods for a cleaner and greener manufacturing processes.

All of us at Rotel thank you for buying this product. We are sure it will bring you many years of enjoyment.

Getting Started

Thank you for purchasing the Rotel RC-1572MKII Stereo Control Amplifier. When used in a high-quality music audio system, your Rotel product will provide years of musical enjoyment.

The RC-1572MKII is a full featured, high performance component. All aspects of the design have been optimized to retain the full dynamic range and subtle nuances of your music. The RC-1572MKII has a highly regulated power supply incorporating a Rotel custom-designed toroidal power transformer and custom-made slit foil capacitors. This low impedance power supply has ample power reserves, which enables the RC-1572MKII to easily reproduce the most demanding audio signals. This type of design is more expensive to manufacture, but it is better for the music.

The printed circuit boards (PCB) are designed with Symmetrical Circuit Traces. This ensures that the precise timing of the music is maintained and faithfully recreated. The RC-1572MKII circuitry uses metal film resistors and polystyrene or polypropylene capacitors in important signal paths. All aspects of this design have been examined to ensure the most faithful music reproduction.

The main functions of the RC-1572MKII are easy to install and use. If you have experience with other stereo systems, you shouldn't find anything perplexing. Simply plug in the associated components and enjoy.

A Few Precautions

WARNING: To avoid potential damage to your system, turn off ALL the components in the system when connecting or disconnecting the loudspeakers or any associated components. Do not turn the system components back on until you are sure all the connections are correct and secure.

Please read this manual carefully. In addition to basic installation and operating instructions, it provides valuable information on various RC-1572MKII system configurations as well as general information that will help you get optimum performance from your system. Please contact your authorized Rotel dealer for answers to any questions you might have. In addition, all of us at Rotel welcome your questions and comments.

Save the RC-1572MKII shipping carton and all enclosed packing material for future use. Shipping or moving the RC-1572MKII in anything other than the original packing material may result in severe damage to your amplifier.

If included in the box please complete the owner's registration card or register on line. Also be sure to keep the original sales receipt. It is your best record of the date of purchase, which you will need in the event warranty service is ever required.

Placement

Like all audio components that handle low-level signals, the RC-1572MKII can be affected by its environment. Avoid placing the RC-1572MKII on top of other components. Also avoid routing audio signal cables near power cords. This will minimize the chance it will pick up hum or interference.

We recommend installing the RC-1572MKII in furniture designed to house audio components. Such furniture is designed to reduce or suppress vibration which can adversely affect sound quality. Ask your authorized Rotel dealer for advice about component furniture and proper installation of audio components.

The RC-1572MKII is supplied with an RR-AX93 remote control and must be placed where the infrared signal from the remote can reach the front panel Remote Sensor.

Cables

Be sure to keep the power cords, digital signal cables and regular audio signal cables in your installation away from each other. This will minimize the chance of the regular audio signal cables picking up noise or interference from the power cords or digital cables. Using only high quality, shielded cables will also help to prevent noise or interference from degrading the sound quality of your system. If you have any questions see your authorized Rotel dealer for advice about the best cable to use with your system.

The RR-AX93 Remote Control

Some functions can be done with either the front panel controls, or the supplied RR-AX93 remote control. When these operations are described, the square call out numbers refer to the main unit, while the encircled letters refer to the remote control.

Remote Control Batteries

Two UM-4/AAA size batteries (supplied) must be installed before the remote control can be used. To install the batteries, remove the cover on the back of the RR-AX93. Install the batteries as shown in the illustration in the battery well. Test the control for proper operation, then replace the cover. When the batteries become weak the remote control won't operate the RC-1572MKII consistently. Installing fresh batteries should eliminate the problem.

AC Power and Control

AC Power Input 24

Your RC-1572MKII is configured at the factory for the proper AC line voltage in the country where you purchased it (either 120 volts AC or 230 volts AC with a line frequency of either 50 Hz or 60 Hz). The AC line configuration is noted on a decal on the back panel.

NOTE: Should you move your unit to another country, it may be possible to reconfigure it for use on a different line voltage. Do not attempt to perform this conversion yourself. Opening the enclosure of the unit exposes you to dangerous voltages. Consult a qualified service person or the Rotel factory service department for information.

NOTE: Some products are intended for sale in more than one country and as such are supplied with more than one AC cord. Please only use the one appropriate for your country/region.

RC-1572MKII should be plugged directly into a polarized wall outlet using the supplied cable or other compatible cable as recommended by your authorized Rotel dealer. Do not use an extension cord. A heavy duty multi-tap power outlet strip may be used if it (and the wall outlet) is rated to handle the current demanded by the RC-1572MKII and all the other components connected to it.

If you are going to be away from home for an extended period of time such as a month long vacation, it is a sensible precaution to unplug the RC-1572MKII (as well as other audio and video components) while you are away.

POWER Switch and Power Indicator 1 A

Press the front panel Power Switch button 1 to turn the unit on. The Power Indicator light is illuminated when the unit is on. Press the Power Switch button again to turn the unit off.

When the power switch is in the ON position, the remote control ON and OFF buttons A may be used to activate the RC-1572MKII. In Standby mode the power LED remains illuminated, but the display is turned OFF.

12V TRIGGER Connection 12

See Figure 5

Some audio components can be turned on automatically when they receive a 12V turn on "signal". The two 12V Trigger Outputs on the RC-1572MKII provide the required signal. Connect compatible components to the RC-1572MKII with a conventional 3.5mm mini mono plug cable. When the RC-1572MKII is in standby mode or turned off, the trigger signal is disabled, so the components controlled by it will be turned off.

Input Signal Connections

NOTE: To prevent loud noises that neither you nor your speakers will appreciate, make sure the system is turned off when you make any signal connections.

Phono Input ¹⁵ and Ground Connection (GND) ⁹

See Figure 3

Plug the cable from the turntable into the appropriate left and right phono inputs. If the turntable has a “ground” wire, connect it to the screw terminal to the left of the Phono inputs. This will help prevent hum and noise.

Line Level Inputs ¹⁵

See Figure 3

The CD, Tuner, and Aux inputs of the amplifier are analog “line level” inputs. These inputs are for connecting components such as CD players or other audio playback devices with an analog audio output.

The left and right channels are clearly labeled and should be connected to the corresponding channels of the source component. The Left connectors are white, the Right connectors are red. Use high quality RCA cables for connecting input source components to the RC-1572MKII. Ask your authorized Rotel dealer for advice about cables.

Balanced (XLR) Inputs ¹⁹

See Figure 4

A pair of balanced XLR inputs accept audio signals from CD player, Blu-ray player or other source components with XLR outputs.

NOTE: You should choose only one method of analog connection from a source component to RC-1572MKII. Do not connect both the RCA and XLR outputs of a source component to the RC-1572MKII at the same time.

Digital Inputs ²⁰

See Figure 5

There are two sets of digital inputs labeled COAXIAL 1 and 2, OPTICAL 1 and 2. Connect the COAXIAL or OPTICAL PCM outputs of your source component into these sockets. The digital signals will be decoded and played by the RC-1572MKII. The unit is capable of decoding PCM signals up to 24 bit, 192kHz.

Output Connections

MONO SUB Output ¹⁶

There are 2 connectors for mono subwoofer output to connect to a subwoofer. These mono outputs are summed with both the left and right audio signal. They are parallel outputs allowing 2 subwoofers to be connected to the RC-1572MKII.

Preamp Output ¹⁷

See Figure 3

A pair of RCA connectors supplies an analog output signal from the RC-1572MKII to a power amplifier with RCA unbalanced input connectors.

Balanced (XLR) Output ¹⁸

See Figure 4

A pair of XLR balanced connectors supplies an analog output signal from the RC-1572MKII to a power amplifier with XLR balanced input connectors.

NOTE: Do not connect both the RCA and XLR to the same amplifier at the same time.

NOTE: Changes to the settings of the Volume, Balance or Tone controls affect the signal from the XLR and Preamp outputs.

Headphone Output ⁶

The headphone output allows you to connect headphones for private listening. This output accepts a standard 3.5mm (1/8”) mini stereo headphone connector. Plugging in a set of headphones does not cut off the signal to the preamp outputs. In most instances you should turn off the power amplifier when listening to headphones.

NOTE: Because the sensitivity of speakers and headphones can vary widely, always reduce the volume level before connecting or disconnecting headphones.

Remote Sensor ²

This remote sensor window receives IR commands from the remote control. Please do not block this sensor.

Display ³

The front panel display shows the source selected, volume level and tone settings. The display provides access to the setup and configuration menu options of the amplifier.

Front USB Input ⁵

The front USB input can be connected to an iPhone, iPad or iPod device providing music playback. Simply plug the device into the front USB and select USB function from the source selector. The iPod and iPhone remain active allowing search and play functions.

APT X Bluetooth Connection ²³

The Bluetooth Antenna ²³ on the RC-1572MKII’s back panel is for wireless streaming via Bluetooth from your device (i.e. mobile phones, tablets or computers). From your device, look for “Rotel Bluetooth” and connect to it. Connection is normally automatic, but if prompted for a password, please enter “0000” on your device. The RC-1572MKII’s supports both traditional Bluetooth, AAC and APT X Bluetooth audio streaming.

Rear USB Power Port ¹³

The rear USB port provides 5V/0.5 amps for charging or powering USB devices including streaming music players. This port does not allow playback of audio.

The port can be configured to remain powered even when the RC-1572MKII is in standby mode through the front panel setup menu (See USB POWER option on page 13).

This configuration option allows the attached streaming source to remain powered for use with the Signal Sense function for automatic power on/off control of the amplifier.

NOTE: When configured to provide continuous power to the rear panel USB port the RC-1572MKII will consume additional power even when in standby mode.

Audio Controls

Volume Control 4 G

Turn the controls clockwise to increase the volume, or counter clockwise to decrease the volume. From the remote control press the volume + or - button to turn the volume up or down. Press the MUTE H button to completely mute the volume.

Balance Control B C

The Balance Control adjusts the left-to-right balance of the sound output. The factory default is the center position or "0". To change the balance from the front panel, press the MENU B button to toggle the front display to BALANCE setting mode. Then press the - or + buttons on the front panel to change the value to LEFT or RIGHT. The value can change from L15 to R15.

NOTE: This setting is saved permanently including after powering off the RC-1572MKII.

To make temporary changes not saved after power off, from the remote control press the BAL C button to access the BALANCE setting menu, then press the up/down/left/right E arrow buttons to adjust.

Tone Control Bypass B C

Bass and Treble Control (Tone Control) circuits are bypassed at factory default to ensure the purest possible sound. To turn on the tone control from the front panel, press the MENU B button to toggle to the Bypass control then press the - or + buttons on the front panel to turn bypass on or off. When tone bypass is set to on, the front display will show TONE BYPASS.

NOTE: This setting is saved permanently including after powering off the RC-1572MKII.

To temporarily changes the Tone Control Bypass, press the BYPASS C button on the remote control to toggle the Bypass mode enabled and disabled.

Bass and Treble Controls B C

To set the Bass or Treble controls from the front panel, press the MENU B button to toggle to the Tone control menu and press the ENTER B button to toggle to either the BASS or TREB Setting menu. Then press the - or + button on the front panel to adjust the value. The Bass and Treble values range from -10 to +10.

NOTE: These settings are saved permanently including after powering off the RC-1572MKII.

To temporarily change the Bass and Treble settings from the remote control, press the BASS or TREB C button, then press the up/down/left/right E arrow buttons on the remote control to adjust the value.

NOTE: Bass and Treble changes are only available when Tone Bypass is disabled (see Tone Control Bypass section).

A properly setup high-performance audio system produces the most natural sound with little or no adjustment of the tone controls. Use these controls sparingly. Be particularly careful when turning the controls up as this increases the power output in the bass or treble range, increasing the load on the amplifier and speakers.

NOTE: Setting the Bass and Treble controls do not automatically turn on the tone control. To turn on tone control, refer to previous section Tone Control Bypass.

Source Input Selector 7 K

Press the corresponding input button on the front panel 7 or remote control K to select the desired listening source.

Push the front panel source buttons to toggle between Optical 1 - 2 and Coaxial 1- 2 or use the dedicated source button on the remote control.

Dimmer Control

Display Dimmer B B

To change the brightness of the front display, press the MENU B button to toggle to the DIMMER Setting. Then press the - or + buttons on the front panel to change the display brightness.

NOTE: This setting is saved permanently including after powering off the RC-1572MKII.

To temporarily change the display brightness, press the DIM B button on the remote control.

POWER LED Dimmer B

To change the brightness of the Power LED on the front panel, press the MENU B button to toggle to the POWER LED Settings. Then press the - or + buttons on the front panel to change the LED brightness.

Valid settings include: BRIGHT, MID, DIM.

NOTE: This setting is saved permanently including after powering off the RC-1572MKII.

Rotel Link 10

Rotel Link is not used for RC-1572MKII.

EXT REM IN Jack 11

This 3.5mm mini-jack receives command codes from industry-standard infrared receivers via hard-wired connections. This feature could prove useful when the unit is installed in a cabinet and the front-panel sensor is blocked. Consult your authorized Rotel dealer for information on these external repeaters and the proper wiring of a jack to fit the mini-jack receptacle.

RS232 14

The RC-1572MKII can be controlled via RS232 for integration with automation systems. The RS232 input accepts a standard straight DB-9 Male-to-Female cable.

For additional information on the connections, software, and operating codes for RS232 control of the RC-1572MKII, contact your authorized Rotel dealer.

PC-USB Input 21

See Figure 5

Connect this input using the supplied USB cable to the PC-USB socket of your computer.

The RC-1572MKII supports both USB Audio Class 1.0 and USB Audio Class 2.0 modes. Windows computers do not require installation of a driver for USB Audio Class 1.0 and support playback of audio up to 96kHz sampling rates. The Factory Default setting is USB Audio Class 1.0.

To take advantage of USB Audio Class 2.0 audio playback supporting up to 384kHz sampling rates you will need to install the Windows driver supplied on CD included with the RC-1572MKII. You will also need to switch the RC-1572MKII to USB Audio Class 2.0 playback mode with the following:

- Press MENU on the front panel until "PC-USB AUDIO CLASS" appears on the display.
- Select "2.0" using the "-" button then press "ENTER".
- Power cycle the RC-1572MKII and reboot your PC after changing the USB Audio mode to ensure both units are properly configured.

Many audio playback applications do not support 384kHz sampling rate. Please confirm your audio player supports 384kHz audio and you have 384kHz audio files to properly playback this sample rate. Also, you may need to configure the audio driver in your PC to output 384kHz or your computer may "down sample" to a lower audio sample rate. For more information please refer to your audio player or operating system information.

The RC-1572MKII has been certified as Roon Tested and compatible with Roon software via PC-USB.



Being Roon Tested means that Rotel and Roon have collaborated to ensure you have the best experience using Roon software and the RC-1572MKII together, so you can just enjoy the music.

For the best user experience it is suggested to use USB Audio Class 2.0 when using Roon.

NOTE: USB Audio Class 2.0 required installation of the Windows PC driver on the CD ROM included with the RC-1572MKII.

NOTE: MAC computers do not require a driver to support PC-USB 1.0 or 2.0 audio.

NOTE: Upon successful installation of the driver, you may need to select the ROTEL audio driver from the audio/speaker setup of your computer.

NOTE: Support for MQA and MQA Studio requires USB Audio Class 2.0. Please select USB Audio 2.0 to support MQA.

Network Connection 22

The RC-1572MKII can be attached to a network using the rear panel NETWORK socket 22. The NETWORK configurations allow both STATIC and DHCP IP addressing. See the Network section of this manual under Setting Menu for IP address configuration information.

The NETWORK connection allows software updates to be downloaded from the Internet. The NETWORK connection also allows IP control for integration with automation systems.

For additional information on the IP control please contact your authorized Rotel dealer.

Settings Menu

You can access the settings menu from the front panel by pressing the MENU E button or the SETUP D button on the remote control. You can change the value of the selected option by pressing the +/- buttons on the front panel or up/down/left/right C arrow buttons on the remote control. Step through the sub-menus by pressing the MENU E button on the front panel or SETUP D button on the remote control.

- Tone Control: TONE BYPASS ON/OFF, BASS level and TREBLE levels can be changed to desired settings. Press the ENTER button on the front panel or the ENT button on the remote control to toggle between the tone setup options. (For more information on Tone Control refer to the Tone Control Bypass, Bass and Treble control sections.)

NOTE: These settings are stored permanently even after the RC-1572MKII is powered off.

- BALANCE: Changes left/right balance (For more information on Balance sections).

NOTE: This setting is stored permanently even after the RC-1572MKII is powered off.

- DIMMER: Dims the display.

NOTE: This setting is stored permanently even after the RC-1572MKII is powered off.

- POWER LED: Dims the Power LED on the front panel.

NOTE: This setting is stored permanently even after the RC-1572MKII is powered off.

- POWER ON MAX VOLUME: This sets the maximum volume level when the unit is turned ON. "45" is the factory default.

NOTE: Power On Max Volume settings do not apply to sources configured with Fixed Gain.

- POWER OPTION: Enables the RC-1572MKII to be controlled via the network port when attached to an automation system. The power consumption is

higher in Quick Power mode. If network control is not required select the Normal Power mode. "Normal" is the factory default.

Valid settings include: Normal, Quick.

NOTE: When the POWER OPTION is configured to Quick, the RC-1572MKII will consume additional power in standby mode.

NOTE: Due to local power consumption regulations the POWER OPTION function is not available in all markets.

- USB POWER: This option allows the rear panel USB connector to provide power, even when the RC-1572MKII is in standby mode.

To enable the continuous power mode select the ALWAYS option. To provide power only when the RC-1572MKII is powered on, select the NORMAL option. The default for USB POWER is set to NORMAL.

NOTE: The front panel power button must be in the ON position to supply power to the rear panel USB connector.

NOTE: When the USB POWER is configured to ALWAYS the RC-1572MKII will consume additional power in standby mode to supply USB power.

NOTE: Due to local power consumption regulations the USB POWER function is not available in all markets.

- AUTO POWER OFF: The RC-1572MKII can be configured to automatically power off if unused for a specified period. If no changes are made to the unit within the specified "Auto Power Off" timer the unit will automatically go to STANDBY mode. The Auto Power Off timer will be restarted if changes are made to the volume, source or playback. The default for Auto Power Off is set to 20 MINS.

Valid settings include: 20 MINS (Default), DISABLE, 1 HOUR, 2 HOURS, 5 HOURS, 12 HOURS.

- FIXED GAIN: Configures a Fixed Volume level for a specified input. To enable this feature press the +/- buttons to select the desired fixed volume level for Aux, USB, PC-USB, Optical 1, Optical 2, Coax 1, Coax 2 or Bluetooth. When enabled and the input with a Fixed Volume is selected, the Volume level will immediately be set to the specified level.

Valid settings include: VARIABLE, FIXED 01-95, FIXED MAX.

- AUX VOL: VARIABLE (disabled) is factory default.
- USB VOL: VARIABLE (disabled) is factory default.
- PC-USB VOL: VARIABLE (disabled) is factory default.
- OPT1 VOL: VARIABLE (disabled) is factory default.
- OPT2 VOL: VARIABLE (disabled) is factory default.
- COAX1 VOL: VARIABLE (disabled) is factory default.
- COAX2 VOL: VARIABLE (disabled) is factory default.
- BTOOTH VOL: VARIABLE (disabled) is factory default.

NOTE: The Volume knob on the front panel and Volume +/- buttons on the IR remote are disabled when the volume is Fixed. To disable this feature set the Fixed Volume level to "Variable".

- PC-USB AUDIO CLASS: Changes supported PC-USB Audio Class of the attached device.

NOTE: Some computers attached to the PC-USB do not support USB Audio Class 2.0 and do not support 32/384 audio playback. If needed the PC-USB can be configured for USB Audio Class 1.0. Please consult your computer operating system for details.

- PC-USB AUDIO MODE: Change PC-USB Audio mode to support MQA and PCM Audio up to 24bits or PCM Audio Only up to 32bits. When PCM 32B is selected MQA audio is not supported. To playback MQA the MQA/24B option must be selected.

Valid settings include: MQA/24B (Default), PCM 32B.

- NETWORK: Shows the network connection status and to view/configure the network settings. If the network is properly configured and attached, "Connected" will be displayed. To view or modify the network settings, press the ENTER button.

The RC-1572MKII supports both DHCP and STATIC IP addressing. Select the desired IP address method and press ENTER.

If DHCP is selected you can refresh IP address by pressing ENTER or press MENU to view IP address information. Press the MENU button to toggle through IP address settings. If the IP address is renewed the network will be tested and connection status reported.

If STATIC IP address mode is selected you must configure all settings for the network including IP Address, Subnet Mask, Gateway and DNS Server. Use the up/down/left/right arrow buttons or the +/- buttons to adjust the values and press ENTER to move to the next value. When the proper IP information is configured press MENU to go to the next setting. After entering the STATIC IP address information the network will be tested and connection status reported.

NOTE: For more information regarding network connection please contact your authorized Rotel dealer.

NOTE: A network connection is not required for the RC-1572MKII to operate.

- MAIN: This shows the current software version loaded into the RC-1572MKII. The software can be updated if the RC-1572MKII is properly connected to the Internet.

- Press ENTER to check if a new software version is available.
- If a new software version is available press the + button on the front panel or the up/right button on the remote control to select YES then press ENTER button to begin the software update process.
- The new software will be downloaded from the Internet. The RC-1572MKII will power cycle when the software update is complete.

NOTE: Do NOT power off the RC-1572MKII during the software update process.

NOTE: It is recommended to Reset Factory Defaults after the software update is complete.

- PC-USB: This shows current loaded software version for PC-USB processor.
- SIGNAL SENSE: Check if an audio signal is present on the configured Signal Sense input. The RC-1572MKII monitors the data stream to determine if there is audio. If there is no audio detected for 10 minutes, the RC-1572MKII will enter Signal Sense Power Mode. When in Signal Sense Power Mode and the RC-1572MKII detects audio on Signal Sense input, the unit will automatically power on. To disable this function, select the OFF option which is the factory default setting.

NOTE: When the SIGNAL SENSE function is activated, the RC-1572MKII will consume additional power in signal sense standby mode.

NOTE: Due to local power consumption regulations the SIGNAL SENSE function is not available in all markets.

- FACTORY DEFAULT: This sets the unit back to the original state as when it left the factory. Press the + button on the front panel or the Right button on the remote control to select <YES> then press the ENTER button on the front panel or the ENT button on the remote control.

NOTE: All previously configured options will be erased and reset to the factory default settings.

Troubleshooting

Most difficulties in audio systems are the result of incorrect connections, or improper control settings. If you encounter problems, isolate the area of the difficulty, check the control settings, determine the cause of the fault and make the necessary changes. If you are unable to get sound from the RC-1572MKII, refer to the suggestions for the following conditions:

Power Indicator Is Not Illuminated

The Power Indicator ring around the power button and the basic items in the Display window should be illuminated whenever the RC-1572MKII is plugged into the wall power outlet and the POWER switch is pushed in. If it does not illuminate, test the power outlet with another electrical device, such as a lamp. Be sure the power outlet being used is not controlled by a switch that has been turned off.

Fuse Replacement

If another electrical device works when plugged into the power outlet, but the Power Indicator still will not illuminate when the RC-1572MKII is plugged into the wall outlet, it indicates that the internal power fuse may have blown. If you believe this has happened, contact your authorized Rotel dealer to get the fuse replaced.

No Sound

Check the signal source to see if it is functioning properly. Make sure the cables from the signal source to the RC-1572MKII inputs are connected properly. Check all the wiring between the RC-1572MKII and the power amplifier, and the speakers.

Cannot Connect via Bluetooth

If you cannot pair your Bluetooth enabled device to the RC-1572MKII, delete the memory of the previous connection on the RC-1572MKII and on your device. On your device this is often listed as "Forget this Device". Then try to make the connection again.

Playable Audio Format

USB Apple (iPhone, iPod, iPad)

Format	Notes
Any supported file loaded to Apple device.	Any supported file loaded to Apple device. Phone may resample depending on stored format. May exclude Apps designed to play formats not originally supported by the sending device.

APTX and AAC Bluetooth

Format	Notes
Any format supported by the sending device.	May exclude Apps designed to play formats not originally supported by the sending device.

PC-USB

Format	Notes
Format determined by the Media Player/Server software that you use.	Any supported format by the PC software: PCM Audio: 44.1 kHz, 48 kHz, 88.2 kHz, 96 kHz, 176.4 kHz, 192 kHz, 384 kHz 16 Bit, 24 Bit, 32 Bit MQA, MQA Studio (24 Bit / 384 kHz) Room Tested

Coax/Optical

Format	Notes
SPDIF LPCM	44.1 kHz, 48 kHz, 88.2 kHz, 96 kHz, 176.4 kHz, 192 kHz 16 Bit, 24 Bit

Specifications

Total Harmonic Distortion (20 Hz - 20 kHz)	< 0.004%
Intermodulation Distortion (60 Hz : 7 kHz, 4:1)	< 0.004%
Input Sensitivity / Impedance	
Phono Input (MM)	3 mV / 47k ohms
Line Level Inputs (RCA)	200 mV / 100k ohms
Line Level Inputs (XLR)	300 mV / 100k ohms
Input Overload	
Phono Input	63 mV
Line Level Inputs (RCA)	4 V
Line Level Inputs (XLR)	5 V
Output Level	
Line Level (RCA)	1 V
Balance (XLR)	2 V
Frequency Response	
Phono Input	20 Hz - 20k Hz, + 0.3, - 0.2 dB
Line Level Inputs (RCA)	10 Hz - 100k Hz, + 0, - 0.2 dB
Line Level Inputs (XLR)	10 Hz - 100k Hz, + 0, - 0.2 dB
Tone Controls	
Bass	± 10 dB at 100Hz
Treble	± 10 dB at 10kHz
Signal to Noise Ratio (IHF "A" weighted)	
Phono Input	80 dB
Line Level Inputs (RCA)	118 dB
Line Level Inputs (XLR)	118 dB
Channel Separation	
Phono Input	> 85 dB
Line Level Inputs (RCA)	> 85 dB
Line Level Inputs (XLR)	> 75 dB
Digital Section	
Frequency Response	20 Hz - 20k Hz (0 ± 0.5dB Max)
Signal to Noise Ratio (IHF "A" weighted)	100 dB
Input Sensitivity / Impedance	0 dBfs / 75 ohms
Preamplifier Output Level	1.44V (at - 20dB)
Coaxial/Optical Digital Signals	SPDIF LPCM (up to 192k Hz 24 bit)
PC-USB	USB Audio Class 1.0 (up to 96k Hz 24 bit) USB Audio Class 2.0 (up to 384k Hz 32bit)* *Driver installation required MQA and MQA Studio (up to 384k Hz 24bit)* Roon Tested
General	
Power Requirements:	
USA:	120 volts, 60 Hz
EC:	230 volts, 50 Hz
Power Consumption	35 watts
Standby Power Consumption	
Normal	< 0.5 watts
Network wakeup	< 2 watts
BTU (4 ohms, 1/8 power)	65 BTU/h
Dimensions (W x H x D)	431 x 99 x 338 mm (17 x 3 7/8 x 13 1/4 ins)
Front Panel Height	2U (88.1 mm, 3 1/2 ins)
Weight (net)	8.4 kg, 18.5 lbs.

"Made for iPod," and "Made for iPhone," means that an electronic accessory has been designed to connect specifically to iPod or iPhone, respectively, and has been certified by the developer to meet Apple performance standards. Apple is not responsible for the operation of this device or its compliance with safety and regulatory standards. Please note that the use of this accessory with iPod, or iPhone may affect wireless performance.

iPhone, iPod, iPod classic, iPod nano, and iPod touch are trademarks of Apple Inc., registered in the U.S. and other countries.



All specifications are accurate at the time of printing.

Rotel reserves the right to make improvements without notice.

Rotel and the Rotel Hi-Fi logo are registered trademarks of The Rotel Co., Ltd, Tokyo, Japan.



ROTEL®

The Rotel Co. Ltd.

Tachikawa Bldg. 1F,
2-11-4, Nakane, Meguro-ku,
Tokyo, 152-0031
Japan

Rotel USA

Sumiko
6655 Wedgwood RD N, Suite 115
Maple Grove, MN 55311
USA
Phone: (510) 843-4500 (option 2)
E-mail: service@sumikoaudio.net

Rotel Canada

Kevro International
902 McKay Rd. Suite 4
Pickering, ON L1W 3X8
Canada
Tel: +1 905-428-2800

Rotel Europe

Dale Road
Worthing, West Sussex BN11 2BH
England
Phone: + 44 (0)1903 221 710
Fax: +44 (0)1903 221 525

www.rotel.com